

# Research Spotlights

---

## **Digitalised World**

How technology changes lives

---

## **Exploring Space**

Research and technology for undiscovered worlds

---

## **Tomorrow's Environment**

Water, air and carbon-neutral mobility

---





## Presidents' Foreword

Alongside continued education, research—and its transfer to society, the economy, administration and politics—lies at the heart of what universities do. The Universität der Bundeswehr München is a medium-sized, but nevertheless very diverse University. Its subject areas span a full spectrum from technological sciences to humanities, social and business sciences. This enables us to deal with complex research topics from an interdisciplinary perspective. In addition to a university comprising seven faculties, the Universität der Bundeswehr München has a university of applied sciences with a further three faculties. This affords us our broad scope, from pure to user-oriented research.

This Spotlight provides you with insight into the range and diversity of our research. This we have done by creating three sections dedicated to our core research areas. All three reflect the modern-day, social relevance of our research activities. You'll find a dedicated section on digitalisation—explored from three different angles. Next we'll take you into space and reveal the numerous ways that research here benefits everyday life. Finally, we'll show how the engineering sciences are solving some of our most pressing questions concerning our environment and sustainability.

We wish you an exciting read!

Two handwritten signatures in blue ink. The signature on the left is 'M. Niehuss' and the signature on the right is 'E. Kern'.

*Univ.-Prof. Dr. phil. Merith Niehuss, President (l) and  
Univ.-Prof. Dr.-Ing. Dr. mont. Eva-Maria Kern,  
Vice-President Research (r)*

# Digitalised World



Digitalisation is ubiquitous. It's redefining how we work, live, buy things and even vote. It's opening us up to new efficient ways of doing things whilst exposing us to fresh threats.

*der Bundeswehr*  
**Universität**  **München**

Research Institute and Research Centers .....	100
Bibliography .....	104
Imprint .....	106
Credits .....	107

<b>Augmented Reality: Marketing Gimmick or Serious Disruptor?</b>	
Philipp A. Rauschnabel .....	08
<b>Smart Hospitals: Digitalising Bavarian Hospitals – the Secure Way</b>	
Wolfgang Hommel, Marko Hofmann and Jasmin Riedl .....	16
<b>The Use of New Technologies in Electoral Processes</b>	
Christina Binder .....	24
<b>Future Work in a Data Society</b>	
Stephan Kaiser and Verena Bader .....	32

# Exploring Space



Space science has added a new dimension to our quest for knowledge which shapes contemporary life. We rely on satellites for navigation and communication. Whilst new technology secures these signals and enhances accuracy.

<b>Navigating Life</b>	
Thomas Pany .....	42
<b>The Role of Satellites in Secure Space Communications</b>	
Andreas Knopp, Christian Hofmann and Robert Schwarz .....	50
<b>Discovering Unknown Worlds</b>	
Roger Förstner and Tom Andert .....	58
<b>The New Way to Outer Space</b>	
Christian J. Kähler and Sven Scharnowski .....	66

# Tomorrow's Environment



Our globally networked world is based on the mobility of data, people and goods. The greatest challenge to the last two is climate change. And technology is progressing quickly to find innovative solutions to the problem.

<b>Future Ready: Sustainable Urban Water Management</b>	
Christian Schaum .....	76
<b>A Healthier Atmosphere: How Measuring Particles and Gaseous Pollutants Helps</b>	
Thomas W. Adam .....	84
<b>CO<sub>2</sub>-Neutral Mobility: From New Fuels to Innovative Combustion Processes</b>	
Christian Trapp .....	92



Our **digitalised world** is defined by a new era of possibility. But how will innovative developments e.g. truly impact us as human beings? Is augmented reality a gimmick or serious disruptor? How secure are IT systems in our hospitals? Will we one day be voting totally online? And what changes can we expect to the future of work for employees and businesses alike?

08

**Augmented Reality: Marketing Gimmick or Serious Disruptor?**

Philipp A. Rauschnabel

16

**Smart Hospitals: Digitalising Bavarian Hospitals – the Secure Way**

Wolfgang Hommel, Marko Hofmann and Jasmin Riedel

24

**The Use of New Technologies in Electoral Processes**

Christina Binder

32

**Future Work in a Data Society**

Stephan Kaiser and Verena Bader









By Philipp A. Rauschnabel

# Augmented Reality: Marketing Gimmick or Serious Disruptor?

There is no doubting that the importance of technology in our lives has increased exponentially. Smartphones, smart speakers and other innovative technologies are commonplace. But until now everything we have ‘seen’ in our physical environment has been real. And that’s starting to change. Recent prototypes for extended reality technologies indicate how our lives in a hybrid reality might be: Our perception of the real world is consistently enriched with virtual content. In other words, we can soon expect a future in which the things that we see might not exist physically, despite their interaction with real, physical things. Welcome to the era of augmented reality (AR)!

While the concept of AR might seem like science fiction, actual observations, numbers and forecasts indicate a fusion of the real and the virtual. For example, in 2016, millions of people played Pokémon GO—the first mobile AR game to hit the mass market. In this game, users ‘see’ virtual creatures as if they are physically present. On the screen of the users’ mobile device, they might appear on a street in front of them. Other promising examples include the IKEA Place app—which allows users to place furniture into their house, or Sephora’s beauty app—which allows customers to use their tablet computer as a virtual AR mirror to test out different make-up styles. Beyond this anecdotal evidence, objective numbers support these observations. For example, Technavio (2017) expects the compound annual growth rate of the AR market to increase 31% by 2021. Likewise, a Goldman Sachs research report concludes that ‘...as the technology advances, price points decline, and an entire new marketplace of applications (both business and consumer) hits the market, we believe VR<sup>1</sup>/AR has the potential to spawn a multibillion-dollar

---

<sup>1</sup> VR (virtual reality) immerses users in a completely artificial and digital environment, typically through a head-mounted display and thus is a different technology from AR.



1



2

---

 Figures 1–2
 

---

*New augmented reality technologies such as Microsoft's HoloLens are the first to bring AR to the home and office space.*

industry, and possibly be as game-changing as the advent of the PC.' Thus, a future in which virtual and real content is realistically combined in novel technologies might not be too unrealistic after all.





At the Department of Business Administration at the Universität der Bundeswehr München, we are conducting fundamental research into exactly what this future will entail. Although AR has the potential to expand its market tremendously, existing technologies can only meet the requirements to lift AR to a mass medium to some extent. For example, operating a smartphone or tablet requires users to devote at least one hand to holding or controlling the device, which might hinder them from properly perceiving and processing AR experiences. In addition, to integrate virtual information into the real world, technologies must 'understand' the real world. That is, technologies must recognise objects, their relative location, and their meaning. Existing technologies can only do this to a limited extent.

In the near future, we can expect technologies that solve these problems to hit the market such as glasses-like devices with transparent screen lenses that track and enrich the real world with virtual content. Prototypes such as Microsoft's HoloLens demonstrate where the journey could take users—a future in which three-dimensional content is realistically integrated into the real world without having the inconvenience of holding or operating a device in one's hands. Recent forecasts indicate that in a few years AR smart glasses will be available for as little as a few hundred euro, have a fashionable design and, most importantly, provide value to users through a variety of apps in entirely new ecosystems. In short, they might be as prevalent as smartphones today. However, many challenges need to be solved, both technical (such as battery power, display technology, and access to fast mobile Internet), legal and societal (such as legal restrictions, implications for human users, and privacy concerns). (Rauschnabel, He & Ro, 2018)

One of the many disciplines that has harnessed great new potential from AR is marketing. Indeed, both marketing academics and managers show a keen interest in understanding more about what consumers do with AR and what AR does for consumers. For example, a recent study by the Boston Consulting Group predicts multiple uses of AR in marketing, such as branding or generating revenue. A recent Deloitte report concludes that AR marketing provides 'new ways to interact with products and services [and offers] companies opportunities to raise awareness, promote features, and inspire desire for their suites of goods.' (Kunkel et al., 2016, p. 1) According to Netimperative, only 10% of surveyed companies are currently using AR, but 72% plan to do so in the near future. However, a lack of knowledge about AR, especially in terms of how it works, remains a major concern. Against this background, this article summarises research on AR marketing and supplements it with practical examples and outlooks. The objective of this article is to stimulate discussions

Table 1

## Examples of AR along the Customer Journey

Stage in the Customer Journey	Example Use Cases	Examples of Common AR Marketing Objectives
Pre-purchase	  <ul style="list-style-type: none"> <li>• <b>Porsche</b> lets users experience their cars at home. Consumers can visualise what such a luxury car would look like in front of their house.</li> <li>• <b>IKEA</b> launched an app for consumers to try furniture at home.</li> </ul>	<ul style="list-style-type: none"> <li>• Providing inspiration to customers</li> <li>• Empowering branding (building awareness, reputation building)</li> <li>• Creating desire</li> </ul>
Purchase	  <ul style="list-style-type: none"> <li>• <b>Domino's Pizza</b> launched an app in the US where customers can 'see' various pizzas on their table. After deciding which they want, they can order directly by using the app.</li> <li>• <b>Amazon</b> just launched a similar function in which consumers can place 3D models of various products at home and order through the app.</li> </ul>	<ul style="list-style-type: none"> <li>• Generating sales</li> <li>• Improving decision making process (through ease of use, 'try before you buy', reducing returned items)</li> </ul>
Post-purchase	 <ul style="list-style-type: none"> <li>• <b>Lego</b> launched AR apps that provide an added value to their existing products. For example, a consumer can buy a knight's castle and the AR app adds virtual fires and figures to it.</li> </ul>	<ul style="list-style-type: none"> <li>• Providing added value through extra AR elements</li> <li>• Improving customer service (by increasing quality, reducing costs)</li> </ul>

about the role of AR in the future of marketing and to provide answers to the question whether AR will remain a gimmick or develop into a disruptive element in companies' future marketing strategies.

## Augmented Reality in Marketing

### Use Cases

Over the past few years, an increasing number of companies have started using AR to address multiple consumer needs and wants. Table 1 provides an overview of examples of how companies currently apply AR marketing, as well as common objectives.

Although these innovative examples come from just a few companies, research has identified a myriad of implications of AR for marketing in general. These range from inspiring customers in specific situations to broader consequences such as the substitution of physical products.



3



4

---

Figures 3–5

---

*A virtual Porsche car is realistically 'parked' in the department's library.*

## The Marketing Implications of AR

### 1. Inspire Consumers

One of the main benefits AR can provide to consumers is 'inspiration'. Inspiration can be described as a 'motivational state that compels individuals to bring ideas into fruition.' (Oleynick et al., 2014, p. 1) Typically, inspiration is evoked via a powerful stimulus, such as an experience (Thrash et al, 2010). Retailers, for example, aim to trigger inspiration by helping consumers visualise what they can do with their products. Our own consumer research found that inspiration has particular relevance for AR:

1. In a recent study, we surveyed consumers' attitudes toward brands before and after using an AR app (Rauschnabel, Felix & Hinsch, 2019). We were particularly interested in the factors that explain the direction and magnitude of this attitude change. Figure 6 summarises the results of a structural equation model. Contrary to our expectations, it was not consumers' evaluation of the app (i.e. how much they liked it) that sparked their attitude change but the degree to which they felt inspired. The positive effects on brands were about four times stronger among the highly inspirational AR experiences.



5

Figure 6

AR can affect brands in many different ways. It can provide direct benefits, act as a source of inspiration and changes in brand attitude.

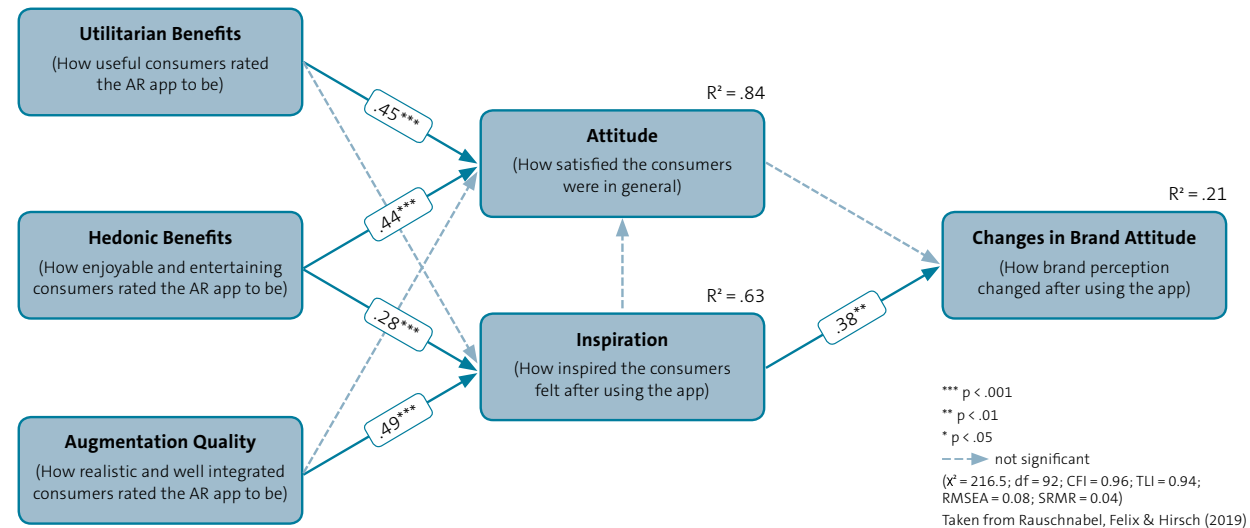

2. To better understand why inspiration matters, we asked consumers to try a Lego AR app in a shopping mall close to our campus before surveying them. The findings indicate that inspired consumers received two benefits. First, they experienced awe (which we would call the ‘wow’ effect in everyday life). Second, inspired consumers also felt nostalgic, and since nostalgic feelings are usually positive, they showed higher purchase intentions. However, the short-term ‘wow’ effect did not show predictive power in explaining intentions, which indicates that AR goes beyond being a simple surprise gimmick.

3. While the previous aspects indicate a high behavioural relevance of inspiration, how stable these effects are over time remains unclear. To better understand this, we conducted a longitudinal survey study in the United States. Participants tried a HoloLens device in a lab setting and answered questions about their experience and

level of inspiration. The HoloLens was new to all the participants. Later, we invited them via email to complete a follow-up study. We found that our effects held even over a period of several days. More specifically, we asked participants how using HoloLens had inspired them over the days to follow and found that consumers who had been initially inspired still felt significantly high levels of inspiration. In addition, these consumers articulated more specific plans about how they could use AR to alter their environment, to substitute physical products with holograms, and so forth.

## 2. Substitution and Complementation

If content can be authentically integrated into a user’s perception of the real world, the question becomes what kind of products might not be needed anymore in the future anymore. Consider, for example, TV screens or art. Microsoft, for instance, recently announced an

MS office version for their HoloLens devices. While these everyday ‘things’ might not be substitutable in the very near future, we might soon see AR substitutes in professional enterprise applications, such as models (e.g. human bodies) in education. Our consumer research shows that consumers can, indeed, imagine situations in which they could substitute real products with virtual products.

The challenge for companies is how to deal with these situations. For example, Lego has just recently developed ‘virtual twins’ of Lego figures and provides content that can complement real products. More specifically, consumers can experience their real Lego products through an AR app and create ‘AR added value’ by augmenting them into real life. This might, on the one hand, mean that consumers substitute real products with virtual ones. On the other hand, it stimulates the desire to purchase more Lego products or to pay extra for AR features.



Figures 7–8

*AR is being used to create branded worlds and challenge conventional advertising.*

*Here a futuristic home is created with AR substitutes (7). The Burger King campaign known as 'BURN THAT AD' was a huge success (8).*

### 3. Creation of Branded Worlds

Human beings have a general need to individualise and alter their environments. Even thousands of years ago, people created drawings and art in their caves. Today, entire industries focus on decoration and interior architecture to satisfy all possible consumer desires. People use various decorative items, including trophies, souvenirs or any other form of art to create a more homely and personalised dwelling. Most previously established technologies were just not able to fully satisfy this desire. Likewise, also brands can serve decorative purposes. For example, sports brands (e.g. posters of a favourite sports club), celebrities or some strong brands (e.g. Coca-Cola accessories) often find their spaces in people's homes.

AR could stand to make all this more convenient and more experiential, for example through virtual objects they might not possess in real life. The term 'desired enhancement of reality' reflects the (expected)

gratification of improving one's perception of the real world in a desired, personalised way (Rauschnabel, 2018). This also includes things that a person might not be able to afford (e.g. expensive luxury items), that do not exist (e.g. fictitious characters) or that are not feasible in other ways (e.g. open fires, torches, wild animals as pets).

### 4. Challenging Conventional Advertising

About one-quarter of the German population uses some sort of ad blockers to hide banners from websites, and companies must deal with this challenge. AR ad blockers integrated into AR smart glasses could present an ad-free environment to consumers. As an aggressive marketing example, Burger King Brazil launched an AR app that incentivised consumers to set competitors' ads on fire (see figure 8). Consumers were encouraged to virtually 'burn' down ads by other fast-food chains with the AR app and received a free Whopper for doing so.

» Augmented Reality is more than just a gimmick. It has the potential to disrupt Marketing and many other disciplines.

### Conclusion: AR Will Be Disruptive

AR is about to become a mainstream medium. Tech companies, as well as media producers, are shifting their resources to AR. Though still in its early stage, AR has the potential to affect almost all business disciplines, including marketing. This article presents research and observations on four selected implications: new ways of inspiration, new ways to experience brands in an AR-branded world, the potential to substitute real with virtual products, and challenges in communicating with customers, such as offline ad blockers. Without doubt, exact predictions are difficult or even impossible and depend on many factors, such as technological developments, user acceptance and legal regulations. However, integrating these predictions into long-term strategy planning and research agendas is a promising way to ensure firms are ready when AR becomes mainstream. When Apple's CEO Tim Cook discussed technological AR challenges to solve, he concluded that AR 'will happen in a big way, and we will wonder when it does, how we ever lived without it. Like we wonder how we lived without our phone today.' Thus, though often still in a trial-and-error phase, AR in marketing has the potential to disrupt current practices, as well as many other (business) disciplines.

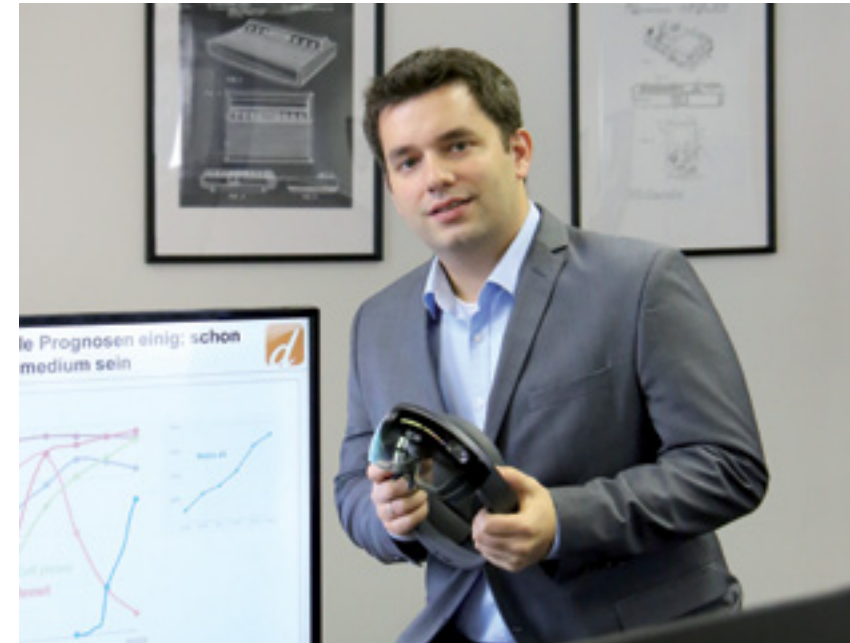

#### Prof. Dr. Philipp A. Rauschnabel

Digital Marketing and Media Innovation

*Professor Philipp A. Rauschnabel has been a tenured Professor of Digital Marketing and Media Innovation since 2018. His research interests include augmented reality, social media, and brand management. In these fields, he has published numerous scientific articles in academic journals, edited books, and spoken at many conferences.*

*XR news: [www.xrealitylab.com](http://www.xrealitylab.com)*





By Wolfgang Hommel, Marko Hofmann and Jasmin Riedl

# Smart Hospitals: Digitalising Bavarian Hospitals – the Secure Way

Digitalisation and technological innovations empower a number of new opportunities for improving health care. But our dependency on technology and software is increasingly a vulnerability as well. Ensuring IT security of critical infrastructures is central to any discussion about smart hospitals. And the Universität der Bundeswehr München is in the middle of the action. At the CODE Research Institute—together with the Bavarian State Ministry for Health and Care—work is being undertaken to develop modern, practical solutions and to provide critical input on securing complex IT landscapes in hospitals.

Hospitals are the physical embodiment of health care. In Bavaria alone, there are approximately 400 of them with over 73,000 beds allocated to inpatient treatment. Importantly, these hospitals also support the local population through their contribution to outpatient services. In a modern society, staying on top of this level of operational complexity is unthinkable without integrated IT software. Software is used for the management of patient admissions, ward management, logistics—such as consumables, medication, food, and laundry—through to accounting. Nowadays, ‘smarter’ medical devices also come fitted with software: Cardiac pacemakers and full-size MRI devices are effectively computers that exchange data with other systems and can be remotely controlled. No wonder, that in terms of the potential of digitalisation, the health sector is one of the biggest growth markets. In fact, the current list of new use cases is endless: Electronic patient records,

» For general hospitals with first to third levels of care and specialist hospitals, the Smart Hospitals project has been established to provide support on how to secure the entire IT infrastructure.

remote monitoring of chronically ill patients, assistive robots for surgical procedures and many more are gaining in currency. And more significantly, making it increasingly difficult to imagine life without them.

### The Side Effects of Progress

Our increasing dependency on IT goes hand in hand with more stringent security measures in hospitals. IT security is essentially concerned with preserving three factors associated with sensitive data: *confidentiality, integrity, and availability*.

1. **Confidentiality:** Patient data is widely recognised to be sensitive. For this reason it is already covered under part of the Hippocratic Oath and hospitals are obliged to keep their data confidential. That's all well and good. But over the past few years, several worldwide cases have come to light in which

hackers have used the Internet to expose large quantities of data—even hijacking entire patient record sets. By late 2017, over 176 million data records had been exposed in the USA alone, some of which were sold on the black market.

2. **Integrity:** People and medical devices must be able to rely on the accuracy of data or its integrity. Information falsified in a patient's records by a hacker can have potentially disastrous consequences for medical treatment. Something as simple as blood type or diabetic measurement values processed by automatic insulin pumps can have fatal consequences for patients.

3. **Availability:** Having access to data and IT systems is essential in order for a hospital to operate effectively. In Germany alone, the past few years have witnessed several hospitals suffering from

catastrophic IT failures. Common causes include malware, introduced via email attachments and infected clinical computers. In 2018, one third of NHS Trusts in the UK were affected by ransomware, rendering computers unusable, and causing significant damage to health services. The consequences of such failures are experienced far and wide: They include postponements of surgical procedures, admission closures and huge additional expenses to maintain care for hospitalised patients.

### Opportunities and Threats

Identified as 'critical infrastructures' by the Federal Government of Germany, medical care institutions are subject to stringent IT security compliance. These are laid out in the IT Security Act and the so-called CIP regulations. Any medical care institution with more than 30,000 inpatients per year is expected

to evidence organisational and technical IT security measures and to report IT security incidents. Smaller hospitals are also expected to rigorously examine this matter particularly within the context of data protection legislation.

It would be wrong to say that this is a development that hospitals are new to. Medical institutions have long been aware of the associated issues with IT security. But while they have protected their systems and data to some extent, they are renowned for having medical complexities that hinder compliance. Take the example of a complex medical device such as an MRI scanner, which typically includes a Windows PC to control the device and store data. In this case, additional software—a virus scanner for example—may not be installed by the hospital's IT administrators because it would render the equipment unauthorised to operate. Add to this

## Patient Records in Hospitals

Data security plays a role in almost all areas



**Figure 1** Number of IT security incidents to be manually processed over the past 12 months

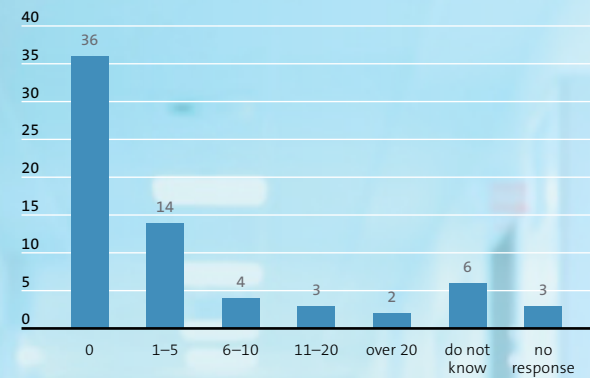

**Figure 2** Documented processes and guidelines for IT security

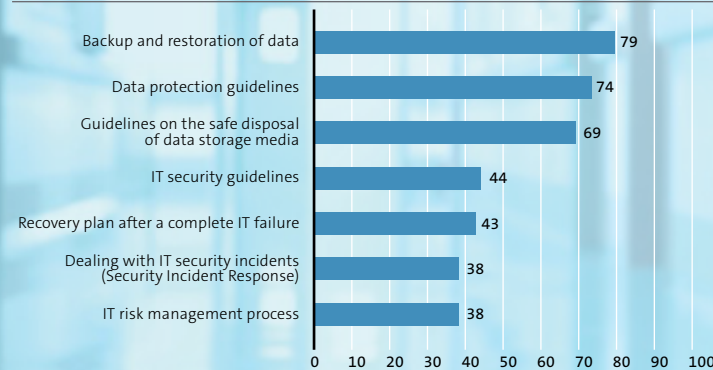

**Figure 3** Technical measures to protect IT

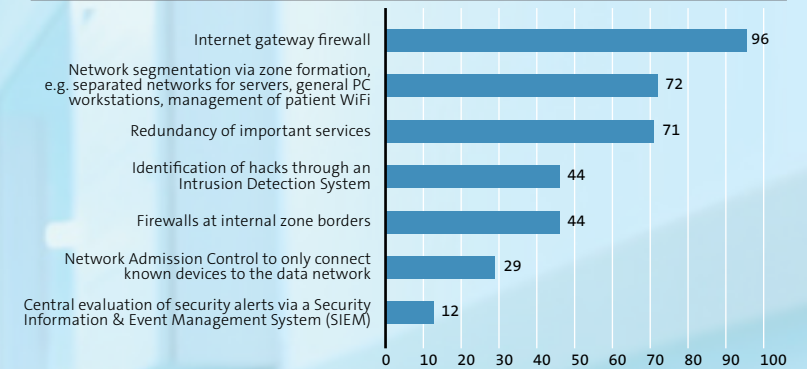

**Figure 4** Initiatives to raise staff awareness about IT security

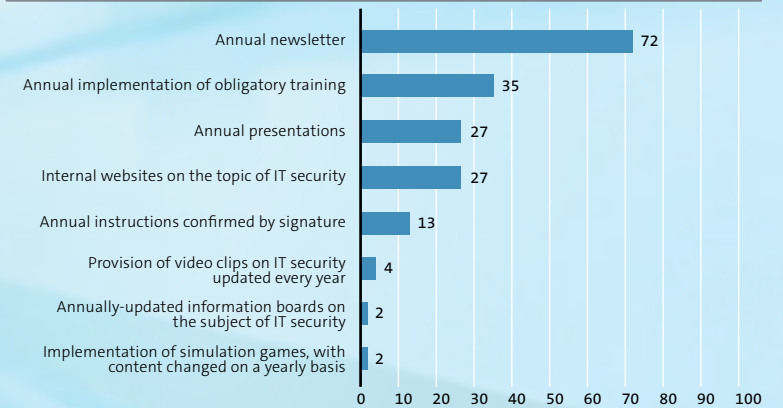

**Figure 5** The seven most challenging future digitalisation trends from the perspective of IT managers

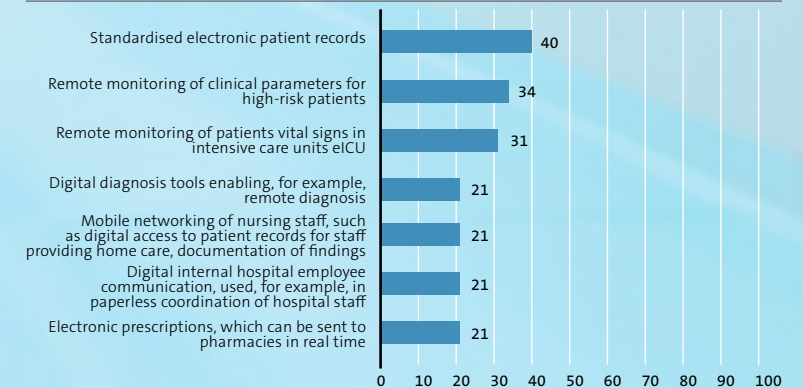

» Any medical care institution with more than 30,000 inpatients per year is expected to evidence organisational and technical IT security measures and to report IT security incidents.

left page · Figures 1–5

*A quantitative survey sent to 400 hospitals in Bavaria illustrates strengths and challenges in terms of IT security. Hospital groups typically have shared IT departments. Out of 220 contacts, 68 responded.*

*(N = 68, Figure 2–5: multiples responses/data in percent)*

the lack of personnel and security specialists within the IT department itself—typical in hospitals and many other organisations—and you start to build a picture of a challenging IT environment: One defined by limited resources, the need to stay ahead and yet strong compliance pressure.

### Help is at Hand

Championed by the digitalisation initiative run by the Bavarian State Government, the Cyber-Defense (CODE) Research Institute at the Universität der Bundeswehr München is trying to navigate this

complex industry and its even more complex IT landscape. And in a very practical way. For general hospitals with first to third levels of care and specialist hospitals, the Smart Hospitals project has been established to provide support on how to secure the entire IT infrastructure. Rather than providing generic industry-wide proposals, the team is working directly with their target group to draw up individualised solutions based on their status quo and current plans. And, of course, support the digitalisation of hospitals in Bavaria.

### Preliminary Results

So how has the team tackled this huge-scale project? Critical to success of the project was clearly going to be the data collected. It needed to be current. That's why the Smart Hospitals team initially carried out a quantitative survey among IT managers across the approximately 400 hospitals in Bavaria. Given that hospital groups in Bavaria typically have joint

IT services, the population of potential respondents actually only amounted to about 220 contacts. The survey achieved a response rate of 36%, which may seem low, but is very successful for this type of survey.

The results illustrate how IT staff themselves assess their existing strengths and challenges in terms of both IT security and future-based digitalisation projects. As Figure 1 shows, over the past year alone, more than one-third of hospitals documented security incidents that had to be processed manually. Incidents included opening phishing emails, breaches to the hospital's IT systems, and the installation of ransomware (extortion through data encryption)—culminating in the unavailability of central services. Figure 2 illustrates a paradox in policy readiness: Whereas over two-thirds of hospitals were able to evidence documented guidelines for data protection, backups and the safe disposal of data carriers, over half of respondents still lack documented recovery plans and Security Incident Response processes. As



Figure 6

*The CODE Institute team comprises (from left to right):  
 Front row: Wolfgang Hommel, Jasmin Riedl, Marko Hofmann  
 Middle row: Verena Jackson, Aylin Borrmann, Julia Hofmann  
 Back row: Nico Hüttel, Siegfried Brunner, Uwe Langer, Michael Steinke, Michael Grabatin*

shown in Figure 3, although almost all hospitals use measures such as firewalls at the gateway to the Internet, dedicated IT security components are only rarely deployed. These might include Security Information & Event Management systems to evaluate log files and Network Admission Control to connect only known devices to the data networks. Developing initiatives to raise staff awareness about IT security issues and the associated rules of conduct reveal themselves to be a low-hanging fruit. As Figure 4 demonstrates, only some 35% of hospitals carry out mandatory training on a yearly basis. Finally, Figure 5 shows how digital innovations, predicted to be part of everyday hospital life over the next ten years, may pose specific challenges to IT security. These include innovations such as electronic patient records, and remote monitoring of high-risk patients including intensive care units.

### From Scientific Results to Tangible Support

The next step was to come up with security measure catalog that could be tailored to each of the participating hospitals. To ensure high relevance, selected hospitals were visited and qualitative interviews were conducted in line with their mandate to provide care, their regional representation and other influencing factors such as local work processes. Similarities and differences were explored in detail to ensure that the full variety of different case types were covered off. The final security measure catalog itself comprises the necessary standards, processes (from planning to implementation) and operational requirements that all IT departments should adhere to. But very importantly, it also contains details and examples for practical application with reference to typical problems and stumbling blocks. The solutions

provided in problem scenarios, have expressly been written in a comprehensive style for application by any IT administrator and can be easily adapted to a variety of IT environments. Thus a full spectrum of relevant scenarios have been provided spanning specifically defined interfaces and standard systems such as email servers, hospital management software and medical equipment assets.

Interim results are also being discussed with Bavarian hospitals in workshops and at IT conferences to inspire suggestions for further assistance. This includes gathering suggestions for quick wins for increasing levels of safety and adoption. This feedback is being used to further optimise individual solutions. Technical innovations and trends emerging in the course of this project have also been incorporated. And will continue to be.

» The final security measure catalog itself comprises the necessary standards, processes and operational requirements that all IT departments should adhere to.

Approximately three million patients receive inpatient treatment in Bavarian hospitals every year. The Smart Hospitals project assures that these patients can trust in two things now—the quality of care and the quality of the systems that protect their personal data. And, additionally, that IT staff can protect vulnerable hospitals from attack. These days research projects can take years to be of practical benefit. Thanks to the Smart Hospitals team, this isn't the case in IT security for Bavarian hospitals.



**Univ.-Prof. Dr. rer. nat. Wolfgang Hommel (l)**

Computer Science Department, Software Technology Institute

*Professor Dr. Wolfgang Hommel has held the professorship for IT Security of Software and Data at the Faculty of Computer Science since 2016. His research focuses on the development and operation of secure networked applications in complex, heterogeneous IT infrastructures.*

**apl. Univ.-Prof. Dr. rer. nat. Marko Hofmann (m)**

Computer Science Department, Computer Engineering Institute

*Professor Dr. Marko Hofmann is Head of the E-Health Division at the CODE Research Institute. His research focuses on modelling and simulation as well as serious games.*

**Univ.-Prof. Dr. rer. pol. Jasmin Riedl (r)**

Social Sciences and Public Affairs Department, Institute of Political Science

*Jasmin Riedl is Professor of Political Science (with a special focus on domestic politics and comparative government). Her research interests include social and political attitudes towards ICT and issues of internal security.*

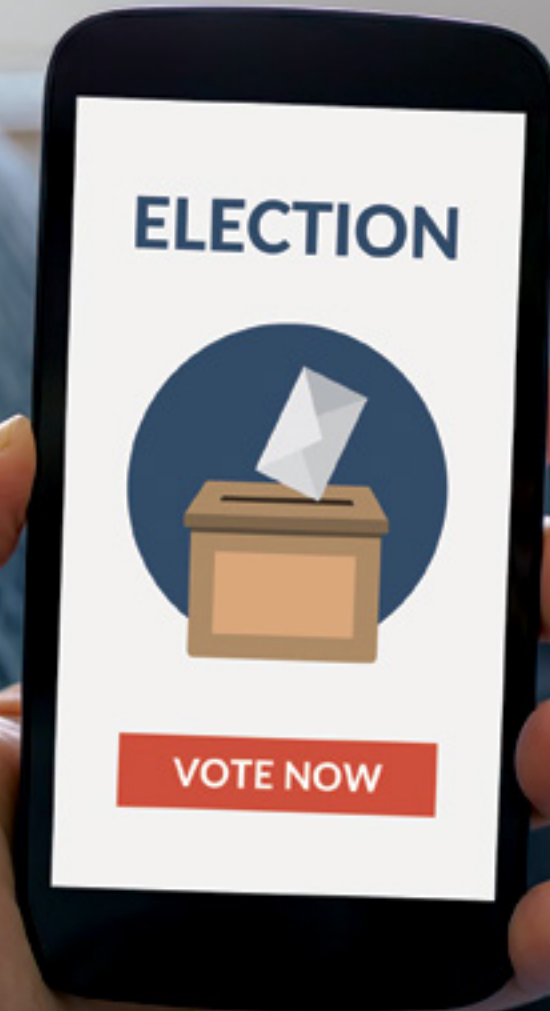



By Christina Binder

# The Use of New Technologies in Electoral Processes

Nearly two billion voters in 50 countries around the world headed to the polls in 2019 to elect their leaders. Some of the biggest elections included India (the world's largest democracy with 800 million eligible voters), Indonesia (187 million registered voters), and Nigeria (84 million registered voters). As they cast their vote, many do so using new types of technology which comes in various forms.

More and more countries resort to voting machines—which either digitally record the ballot paper or enable direct electronic voting. More advanced examples include online voting, which—while not yet commonplace and to date only practised in a few countries such as Estonia—make casting one's vote from the comfort of one's own home a reality. It is certainly fair to say that new technologies bring with them an almost limitless number of potential use cases. Going forward, these technologies will not just be deployed on election day but during other phases of the electoral process, such as voter registration or vote counting. Currently, however, most developments are being made in deploying these technologies on election day itself.

Harnessing new technologies during electoral processes comes with the advantage of simplifying the voting system and rationalisation. In the future, for example, voting from abroad might become easier. But there are still a number of challenges. These include, in particular, preserving the integrity of the electoral process (voting secrecy, protection



Figures 1 – 2

*Observation of the local by-elections in Armenia in September 2016 with the Congress of Local and Regional Authorities of the Council of Europe.*

from electoral fraud, etc.), not to mention upholding voter confidence. Likewise international election observers themselves are required to understand any new technologies being deployed in electoral processes in terms of observation methodology. Taking all these points into consideration: How may the potential use of new technologies in the electoral process be assessed?

This question is one of the key focus areas of research done at the Institute of Public Law and International Law at the Universität der Bundeswehr München. Headed up by Christina Binder, Professor of International Law and International Human Rights Law, multi-level research is carried out here into the use of new technologies in the electoral process. On a scientific level this happens in the context of publications and lectures which deal with applicable standards and challenges arising in the process.

But as a consultant for international organisations (Council of Europe, OSCE/ODIHR) and as an expert in election observation missions in countries where new technologies are being used (e.g. Estonia), Christina Binder has a reputation for her practical focus. This ensures that real-world experience flows back into research and also builds out the empirical data available for scientific analysis.

### **Establishing an Assessment Framework for the Use of New Technologies in the Electoral Process**

When examining the use of new technologies in electoral processes, a first question relates to the applicable assessment framework. A major source of guidance here are the legal standards governing elections. In international law, for example, Article 25(b) of the International Covenant on Civil and

Political Rights regulates each citizen’s right: ‘To vote and be elected at genuine, recurring, universal, equal and secret ballots, which ensure the free expression of the will of the electorate.’ This also includes the openness and transparency of elections. Similar standards can be found in Article 38(1) of the German Grundgesetz regarding the election of members of the German Bundestag. Here too, the law calls for a universal, direct, free, equal and secret ballot.

The electoral standards and principles laid down in these instruments may be detailed as follows:

1. The notion of the secret ballot demands secrecy regarding how someone voted. In other words, it must not be possible to trace votes back to the electorate who cast them. This applies just as much to online voting as it does to offline.
2. The openness of elections calls for results to be transparent and specifies the need for

accountability regarding the counting of votes. This stipulation, central to voting integrity, applies in equal measure to votes cast online.

3. The universal right to vote—with the central aim being to achieve the most comprehensive and broadest possible voter turnout—is a benchmark for the impact of new technologies on voter participation.
4. Equal elections refer to the fact that each person should have only one vote with each vote having the same voting power. This too must be ensured when new technologies are used.
5. Further standards include the free expression of the voter's will. This must be ensured in Internet voting as well. In particular, outside the secure environment of the polling station, the danger of voter manipulation is at its greatest. Therefore, a central matter in all of this, is the preservation of voter confidence in the electoral process.

This framework of (international) electoral principles and standards provides a helpful benchmark against which to measure the benefits and challenges of the use of new technologies in the electoral process.



### Use Case: Voting in Estonia the Internet Way

Internet voting has been possible in Estonia in all types of elections as an alternative to in-person voting in polling stations since 2005. It was widely used, for instance, during the 2019 Estonian parliamentary elections. Here 43.8 percent of votes were cast online.

The Estonian Internet voting system builds on the Estonian digital identity card. Every Estonian possesses such a card which may be used for remote authentication. Thus, it can be used for voter identification purposes in conjunction with specific infrastructure provided by the Estonian state.

In January 2019, over 1.3 million cards were used—which equates to a use by 98 percent of the country's population. Internet voting is possible during an early voting period from the tenth until the fourth day before election day. Voters can change their electronic votes an unlimited number of times, with the final vote being tabulated. It is also possible for anyone who votes on the Internet to vote at a polling station in the early voting period, therewith invalidating the vote cast online. A comparison of the cost-efficiency of the different ways of voting during the Estonian 2017 municipal elections concluded that Internet voting was the most cost-efficient way of voting offered by the Estonian electoral system.



**2.36** minutes to vote via internet



**98** percent of the country's population use the digital identity card

**504,000** euro cumulative time savings in wages





» Outside the secure environment of the polling station, the danger of voter manipulation is at its greatest.

### **The Potential Benefits of New Technologies**

Among the major benefits of using new technologies is the possible increase in voter turnout. This is due to the fact that currently citizens who are unable to come to a polling station in person—perhaps due to residency abroad, illness or disabilities for instance—are precluded. This could change with the use of new technologies provided that those individuals have access to a computer.

Another potential benefit is the level of information made available to voters. Web-based interfaces make it possible to educate voters about candidates, manifestos and ultimately empower voters to participate in a more informed way.

Additional advantages include the rationalisation of processes through new technologies as regards a more efficient counting of votes and the publication of results etc.

And of course, over time, cost is a big factor. The regular use of new technologies create cost-efficiencies and reduce the need for resource-intensive staffing.

### **The Potential Challenges of New Technologies**

One of the key challenges relates to the identification and authentication of voters which—if unreliable or insecure—has the power to undermine the integrity of the electoral process altogether.

Other concerns include reduced accessibility: Not everyone in society has access to new technologies meaning that Internet voting could discriminate against the poor, educationally disadvantaged and/or those from rural population groups. This could ultimately have significant negative effects on the universality of the election.

Another potential problem concerning the openness of elections are voter concerns regarding the storing and counting of their votes online. And, given that voting online no longer happens within the controlled environment of the polling station, an even more threatening challenge is the risk of voter manipulation or vote buying. After all, in this constellation, voters themselves are responsible for ensuring the secrecy of the ballot. These last challenges all roll up into

the single biggest threat of new technologies—their impact on voter confidence.

### Solutions to Challenges

That said, there are a number of possibilities to meet the challenges posed by new technologies in elections and increase voter confidence in the process. These include initiatives such as ‘voter education’ which seek to inform voters about the technicalities of the election; the certification and verification of the electoral process by an independent body; the option of manual counts to verify the ballots cast (with computer-assisted elections in the polling station); and generally, the greatest possible transparency in regards to the way the system functions. In case of remote-voting via the Internet, a multiple voting system with only the last vote cast actually being counted could be deployed to reduce the risk of external influence or manipulation. This is a securer option as the final vote could then be cast at another time. Depending on how comprehensively measures such as the above are applied, it may be possible to limit the challenges and risks that new technologies pose to the electoral process. Certainly, the use of new technologies is to be assessed situatively and according to their actual use (elections in the controlled environment of the polling station versus voting in an uncontrolled environment at home), whilst still taking into account factors such as voter confidence, etc. Ultimately, any assessment of the use of new technologies in electoral processes must happen on a case by case basis. After all, each case is different which makes it more difficult to turn to generalisations.



### The OSCE Office for Democratic Institutions and Human Rights (ODIHR)

ODIHR provides support, assistance and expertise to participating states and civil society to promote democracy, rule of law, human rights and tolerance and non-discrimination. ODIHR observes elections, reviews legislation and advises governments on how to develop and sustain democratic institutions.

So far, ODIHR has deployed over 250 election observation missions. Election observation missions usually consist of a core team in the capital with various experts (legal, political, election, media etc.) who analyse different aspects of the election process; long-term observers deployed in the different regions of a country to assess the election process in the regions; and a large number of short-term observers who observe the actual vote in polling stations throughout the country on election day.





*Figure 3*

*A voter's finger being scanned at a polling station in Bishkek during Kyrgyzstan's parliamentary elections on 4 October, 2015. A new biometric voter identification system was first used in these elections.*

### **International Election Observation: A Change All Round**

The application of new technologies in the election process also represents a challenge to international election observation as it naturally requires observers to adapt their methodology. Of course, international election observers have ample opportunity to assess the use of new technologies. An election observation mission (EOM)—sent by the OSCE/ODIHR for example—not only observes the election day itself but also analyses various aspects in the run up to that election—voter and candidate registration, voter education and the election campaign, for example. Observers thus tend to have a focus that enables them to evaluate the use of new technologies over the entire electoral process.

These days, when new technologies are used, a key role is played by the e-voting expert who is integrated

into the core team. The e-voting expert adds to the assessments of other experts (the legal analyst, election analyst, political analyst, etc.) by providing perspectives on new technologies. Furthermore, long-term observers can be used to identify general trends, for example, regarding voter confidence and voter education initiatives throughout the country also in relation to new technologies. On election day itself, the large number of short-term observers (up to 300-400 people on OSCE/ODIHR missions), provide a comprehensive picture of the use of new technologies in polling stations on a rather quantitative and statistical basis.

In response to the challenges associated with the use of new technologies in elections, organisations such as the OSCE/ODIHR have developed their approaches to election observation. These are documented in various manuals. Also a certification of the IT-system and the trial use of new technologies (e.g. via mock

elections in the presence of observers including the e-voting expert) are available and useful to build voters' confidence.

All in all, it's clear that new technologies are not just relevant for the electoral process itself. Technology also has the potential to revolutionise election observation as well. ODIHR election observers, for example, can now electronically transmit the observations made on election day rather than scanning their observation forms one by one, as was previously the case. Furthermore, election observers can use computer-assisted technology to quantitatively determine trends in voter behaviour on election day. There is thus huge potential here.

### **More Need for Interdisciplinary Research**

The widespread use of new technologies throughout electoral processes is now a reality. And we can expect this to keep growing—both in terms of voting at

» There are a number of possibilities to meet the challenges posed by new technologies in elections and increase voter confidence in the process.

polling stations (computer-assisted or digital voting) as well as remote voting from home. This being said, a lot more research needs to go into exploring the benefits and challenges of using new technologies. Any such analysis should be made on the basis of and with reference to international electoral standards and best practices. The results will certainly be context-specific and depend on various factors that include: usage (remote voting vs. voting in polling stations), transparency, voter confidence, and local conditions to name but a few. Either way—there is a lot of room for research and academia to get involved. And it should not happen in isolation—key stakeholders must come from all fields of science. After all, this is a broad area requiring inter- and transdisciplinary collaboration, a practice-oriented approach and empirical research to back theories up. What is at stake, in the end, are voters' rights and more generally, the future of democracy as a whole.



**Univ.-Prof. Dr. Christina Binder, E.MA**

Institute of Public Law and International Law

*Christina Binder is Professor of International Law and International Human Rights Law at the Universität der Bundeswehr München. Prior to this she was University Professor of International Law at the Department of European, International and Comparative Law at the University of Vienna and Deputy Director of the interdisciplinary 'Human Rights' Research Centre. Professor Binder is a member of the ILA Committees on the 'Implementation of the Rights of Indigenous Peoples' and on 'Human Rights in Times of Emergency' and a member of the Executive Board of the European Society of International Law (ESIL). She has also served as a legal and electoral expert for the EU, conducted OSCE/ODIHR election observation and assessment missions in several countries and is electoral expert for the Congress of Local and Regional Authorities of the Council of Europe.*





By Stephan Kaiser and Verena Bader

# Future Work in a Data Society

The digitalisation of society and the economy requires changes to be made to companies and their working environments. For corporate governance, management, employees, their representatives in works councils and numerous other stakeholders this brings major change and uncertainty with it. No wonder that over the last few years, management research has devoted itself intensively to the phenomenon of digital transformation in the working world.

The team at the Department of Economics and Management at the Universität der Bundeswehr München has dedicated itself to identifying three specific issues arising from digital transformation that might be preventing companies from moving forward. These are then explored in more detail.

1. **Complexity:** Many companies are simply overwhelmed by how complex digital transformation is. Almost every area of any business is affected and inevitably all developments are interconnected: Change one thing and you change everything. This can make it hard to know where to start.
2. **Contradictions:** Studies demonstrate that there appears to be numerous inconsistencies between research and actual practice, which is resulting in apparent contradictions within organisations. This means that decision making is delayed while these contradictions are reconciled.

» Any sustainable organisation knows that its future lies in the intersection between digital communications and hyper-connectedness.

3. **Insecurity:** The availability of data insights and the introduction of artificial intelligence into the digital workplace both play a central technological role in the future of work. Research indicates that algorithms are potentially changing the way human decision-making behaviour happens. This is causing companies to be insecure about the impact of technology on human decision making.

### Managing the Complexity of Digital Transformation

Any sustainable organisation knows that its future lies in the intersection between digital communications and hyper-connectedness. But numerous developments at the point of this intersection make it very difficult for companies to know where to start. These include developments

such as real-time analytics, digital information spaces (e.g. the cloud or simplified dashboards) or remote/virtual working. And they all affect how a company will work in the future.

Finding answers to these questions is made more difficult by the high level of transformational complexity (multi-dimensional and inter-relational). These developments not only affect both individual employees and managers, but also organisational structures and cultures as well as leadership and collaboration.

In order to find answers, the University has developed a configuration theory-based approach as part of its DigiTrain 4.0 project—funded by the Federal Ministry of Education and Research (BMBF). In this project, it is assumed that various levels and dimensions

of the organisation are mutually connected and that it is necessary for organisations to adopt a holistic approach. This complexity is represented in the so-called ‘Digitalisation Atlas’ made up of three levels: the organisational level (e.g. processes and corporate culture), the individual level (e.g. competences and motivation) and the interaction level (e.g. leadership and collaboration). For these three levels, the atlas structurally depicts the dimensions that are associated with each level, their influence on employees, and how they are connected with other dimensions across the organisation. It’s designed to be a practical tool that companies can use to systematically support and guide their digital transformation.

The ‘Digitalisation Atlas’ comes with two other tools to assist organisations. The ‘Digitalisation Index’ is

a measuring kit that's been developed to determine the level of digital maturity an organisation has. The 'Transformation Agenda' is effectively a compass that a company can use to define its digitalisation goals and pursue a suitable path to digital transformation.

### Contradictions in the Digital Employee Experience and Related Employment Relations

The already complex process of digitalisation becomes more challenging because people experience it contradictorily in their everyday practices. In a research project funded by the Hans Böckler Foundation, the University has examined how strategic partners in the field of employment relations attempt to reconcile these contradictions. In a preliminary study, the frameworks for dialogue around digitalisation that



Figure 1

The 'Digitalisation Atlas' is made up of three levels: the organisational level (e.g. processes and corporate culture), the individual level (e.g. competences and motivation) and the interaction level (e.g. leadership and collaboration).



Figures 2–4

The team at the Department of Economics and Management test out their DigiTrain board game conceived as part of their configuration theory-based approach to organisational management.



Figure 5

Employees and executives must deal with numerous contradictions and ambiguities in the context of the digitalisation of work environments.



these strategic partners have developed were analysed. The below highlights how these may be construed as contradictory in terms of the employee.

1. **Agency Ambiguity:** Employees are frequently informed that digital technologies can enhance their existing human capabilities. Yet this concept of sophistication is a paradox. Yes—employees can certainly improve their professional work with better tools—but they may lose individual capabilities in the process.
2. **Technical Ambiguity:** Technology facilitates the dissemination of information. On the one hand, for example, employees can use data insights to enhance organisational performance and their ability to shape the end result. But, on the other hand, pre-determined intransparent algorithms can disempower—turning users into ‘mere’ agents.

3. **Work Design Ambiguity:** Another contradiction arises when considering new ways of work. Digitalisation in the workplace enables more transparency around optimal working environments and the corresponding individual performance. But it stands to reason that this goes hand in hand with employees being more closely monitored.

As a logical next step into these investigations, the University analysed the dynamics under which companies deal with these contradictions. In its more traditional form, for example, ‘Operational Co-determination’ sees companies controlling the use of digital technologies in the workplace. This is defined by their blocking anything associated with performance monitoring and behavioural change. And ultimately leading to the potential of digitalisation remaining untapped. ‘Co-determination 4.0’ is different. Under this dynamic, employers and employees collaborate to create new practices. This form of co-

determination is characterised, for instance, by the increased digitalisation of the works council itself, experimentation with new ways of working, the joint design of digital technologies by HR and employees themselves, and a fresh cultural understanding of the works council’s role in facilitating a sustainable working environment for employees.

Going forward, companies will increasingly attach particular importance to the topic of ‘People Analytics’. This will see them analysing (on the basis of their data sets) each and every decision taken concerning their personnel and it will certainly raise a number of questions that are currently far from answered.



### Insecurity around Learning Algorithms and Decision-Making

Organisations are increasingly involved in systematically analysing the data they generate from intelligent algorithms. This means that ‘datafication’ and ‘algorithmisation’ have long become integrated into the internal structure of a company and the working world as a whole. Emphasis, nowadays, is increasingly on how employees can make better decisions as a result of the information they have access to. And with data availability, advanced computing power and machine learning, this is entirely realistic.

But it may involve redefining traditional ways of thinking about things: Any decision taken with the help of digital technology can no longer be regarded as a purely human decision. After all, that decision has ultimately been ‘distorted’ by a pre-defined learning algorithm. Digital transformation can be viewed in this context in two different ways. On the one hand—as triggering the merging of human and artificial intelligence: In which the boundaries of the human mind are expanded through structured access to more information and fresh data. But on the other hand—as triggering a decline in human intelligence: One in which the human mind is deprived the information it needs to really understand the results it sees, instead outsourcing this to intransparent algorithms.

### Use Case: Learning Algorithms in Sales

The University has been busy researching the true impact of learning algorithms on the human decision-making process. A team of sales consultants were studied with this goal in mind. Would they let learning algorithms control their decisions or override the information they were given? The results showed that the sales team did a subtle combination of both. Firstly, they would distance themselves from the decision-making process using algorithms to guide them. This came down to the fact that—unlike algorithms—they only had a restricted context with no access to external or historical information (data). But this didn’t mean that they were not involved in

» It is possible that algorithms make their decisions based on a distorted digital impression of reality, whilst human actions actually deviate from optimal decision-making behaviour.

the decision-making process at all. Indeed, owing to their proximity to the infrastructure responsible for the information and their emotional involvement they did identify themselves as involved in the decision. Of course, it will be important, going forward, to raise awareness about the dangers arising from the improper use of AI in the workplace, e.g. through attempts to bypass intended procedures or manipulate data.

It is possible that algorithms make their decisions based on a distorted digital impression of reality, whilst human actions based on algorithmic decisions actually deviate from optimal decision-making behaviour.



**Univ.-Prof. Dr. rer. pol. Stephan Kaiser**

Institute of Development of Sustainable Organisations

*Stephan Kaiser has been Professor of Human Resource Management and Organization at the Universität der Bundeswehr München since 2009 and is working for the Institute for Development of Sustainable Organizations at the Department of Economics and Management. He holds a doctorate from the Catholic University of Eichstätt-Ingolstadt. His research and teaching focuses on human resources management, organization and corporate management.*

**Verena Bader M.A.**

Institute of Development of Sustainable Organisations

*Verena Bader is a Ph.D. candidate in Human Resource Management and Organization studies at the Universität der Bundeswehr München. In 2019, she was also a visiting Ph.D. at the KIN Center for Digital Innovation at Vrije Universiteit Amsterdam. Her research interests lie at the intersection of information systems, organization, and work. Specifically, she focuses on research questions in the areas of digital technologies in their relation to human actors. Beyond, she analyzes how strategic actors in the field of employment relations deal with digitalization. This is funded by the Hans Böckler Foundation.*



The way to outer space is still uncharted territory. But with new technology enhancing the speed and accuracy with which we can launch into and navigate foreign worlds, **exploring space** is changing. Satellite communication is also advancing and research into high-accuracy GPS is smoothing the way for autonomous driving.

42

**Navigating Life**

Thomas Pany

50

**The Role of Satellites in Secure Space Communications**

Andreas Knopp, Christian Hofmann and Robert Schwarz

58

**Discovering Unknown Worlds**

Roger Förstner and Tom Andert

66

**The New Way to Outer Space**

Christian J. Kähler and Sven Scharnowski

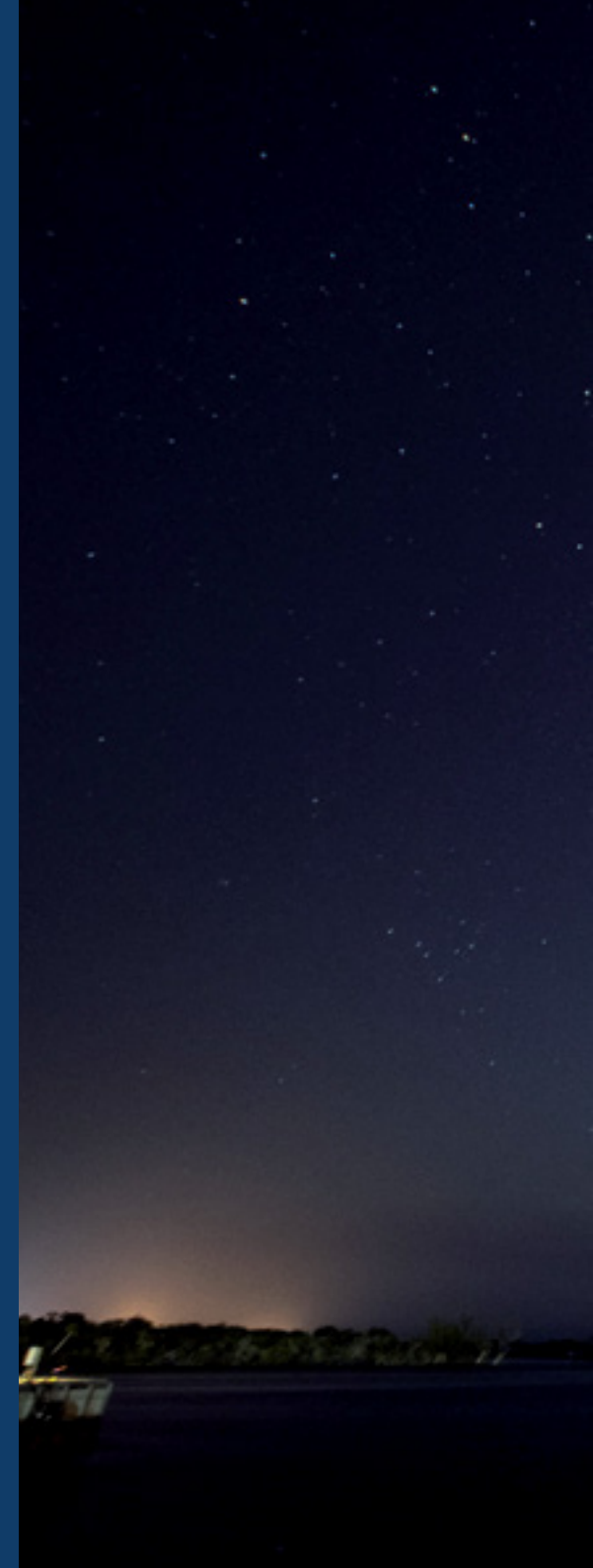







By Thomas Pany

# Navigating Life

Humans have long been able to find their bearings on their own. But satellite navigation has certainly made things a lot easier. It has been almost 50 years since GPS was invented and over 100 navigation satellites from America, Russia, Europe and China now orbit planet Earth. Celebrated for their contribution to developing European satellite navigation, the Universität der Bundeswehr München is regarded to be a cornerstone of science. And while the division behind this achievement are hard at work developing even more cutting-edge solutions, satellite navigation continues to be used by billions of people worldwide—and closer to home—is a symbol for a strong, united Europe and a strong Germany.

## **Institute of Space Technology and Space Applications (ISTA)**

The Space Exploitation Division of the Institute of Space Technology and Space Applications (ISTA), at the Universität der Bundeswehr München is led by Professor Pany, Head of Satellite Navigation. Since 1983 the team has been responsible for areas that include global navigation satellite systems (GNSS), precise positioning, inertial and optical navigation and the world-renowned European satellite navigation system Galileo. The Institute's predecessors, Professors Hein and Eissfeller, continue to be connected to the Institute as Emeriti of Excellence. On site in Munich, the team concentrate on theoretical studies, developing prototypes for hardware and software as well as conducting application-orientated test exercises. The application of their research ranges from smartphone technology to autonomous driving right the way through to interplanetary travel and asteroid mining.



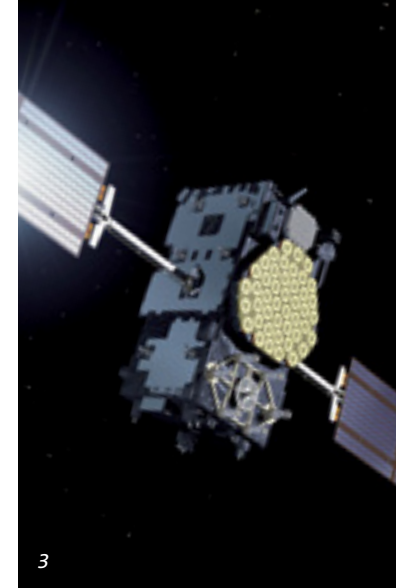
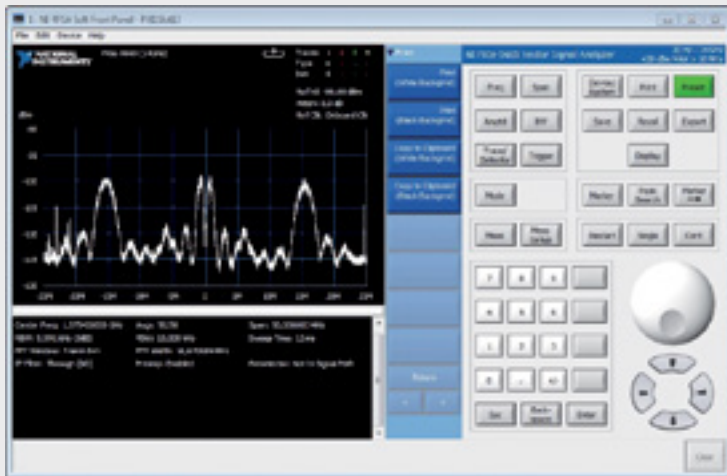

Figures 1 – 3

The Institute's satellite navigation signal measurement equipment showing the signals at 1.57 GHz broadcast from one Galileo satellite.

The Institute is exceptionally proud not only of its heritage but also of the role it still plays at the cutting edge of scientific discovery. It's hard to single certain projects out, but there are currently 11 in particular, that are leading the way in research.

Currently approx. 20 full-time employees working at the Institute who are predominantly financed via third-party funds and mainly recruited from the geodesy, physics, electrical engineering, aeronautical engineering and IT disciplines.

### Galileo: Signals and Frequency

A major part of the currently transmitted Galileo signal structure was developed more than ten years ago at the Institute. Enabled through cooperation with other European institutions, these signals are now received by more than a billion mobile telephone

users (status December 2019). Involved in various Galileo working groups at the European Commission in Brussels, the team also cooperates with the Federal Ministry of Transport and Digital Infrastructure (BMVI).

One area of current focus is that of GNSS satellites. These satellites send navigation signals on the same frequency. For this reason it's critical that they comply with certain standards so as to ensure that Galileo signals don't interfere with the reception of GPS signals. With this in mind, the Institute is developing calculation models for second generation Galileo signals and comparing them with international partners.

Satellite navigation also shares the same spectrum as other radio services. Hence, Galileo has the primary right of use in the E6 frequency band (approx. 1278

MHz) and amateur radio has a secondary right. In order to ensure simultaneous operation, the Institute is conducting measurement exercises together with amateur radio operators and the Federal Network Agency. Work is also being carried out on developing innovative architectures in order to make GNSS receivers more robust.

### Galileo: High Accuracy Service (HAS)

Future navigation applications such as autonomous driving or augmented reality, require a high level of precision in the centimetre and decimetre range. Such precision is currently only available in open-air environments and not in urban areas. That is why additional services and signals are being developed for Galileo. As part of the Galileo 'High Accuracy Service' (HAS), centimetre-precise satellite positions and satellite clock parameters will be transmitted from

2020 onwards. Currently, the Institute is adapting this service for autonomous driving with a view to delivering an open source reference implementation for the user (end receiver). Another key element is the accurate determination of the distance between satellite and users. To this end, the Institute is examining signal options that could be used as a third component in the Galileo Open Service signal on E1. The merging of GNSS signals with mobile radio signals (LTE/5G) is also being examined for the purpose of better navigation.

### The Perfect Test Environment

It's not always easy to perfectly replicate how signals are received. That's why the Institute is developing a UAVlite test system in order to accurately understand the effect of signals in real-life environments. In this environment, GNSS satellites are emulated using multicopters and emit new navigation signals with a payload developed at the Institute. A network of ground stations on the university premises receive signals, determine their position and clock errors emitted by the UAVlites.

Figures 4 – 5

The UAVlite shown on the right emulates a second-generation Galileo satellite. Below the test environment with emulated Galileo ground stations and interference sources.



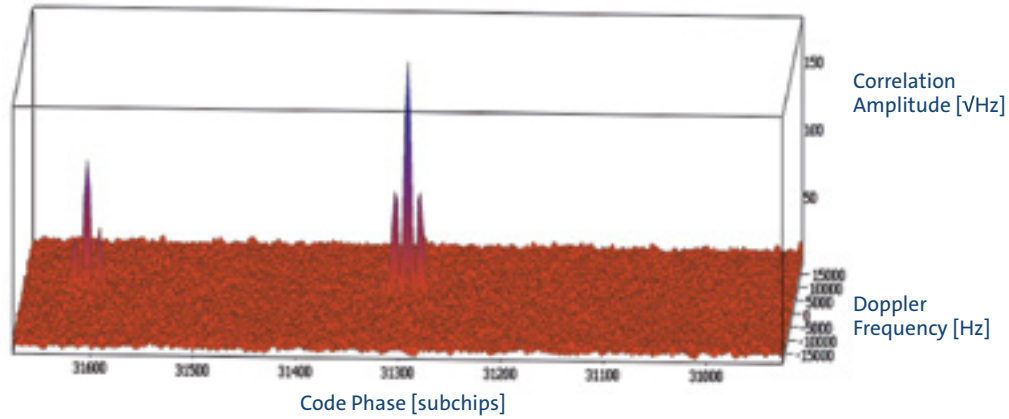

6

Figures 6–7

Below, the image depicts a hidden setup to broadcast counterfeit GNSS signals. These signals appear as additional peaks on the GNSS receiver which are larger than the original satellite signals (top).

7



### Combatting Counterfeit GNSS Signals

Protecting GNSS signals from being counterfeited is now crucially important in the context of the cyber security debate. This applies as much to the military as it does to civilian applications such as digital road tolls, computer games and deep-sea fishing. Secure applications are now commonplace not just in aviation but also in power grid synchronisation or mobile radio networks. In this context, the Institute is simulating counterfeiting scenarios and analysing GNSS signals (Galileo PRS) for their robustness. Theoretical investigations and real-world simulations are also being carried out to find more innovative, counterfeit-proof signals (authenticated signals).

### Inertial Navigation

Satellite navigation is very often supplemented by inertial navigation. To do this, rotation rates and accelerations are added together and combined with the GNSS position. The resulting fusion system is more robust in terms of its range and can also

Figures 8–11

A LiDAR mounted on a calibration setup (9) generates LiDAR measurement data (8). Below these are screenshots taken from the GNSS software receiver.

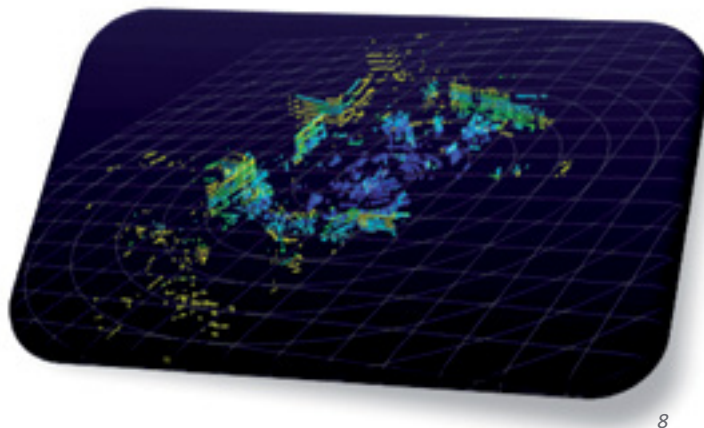

8

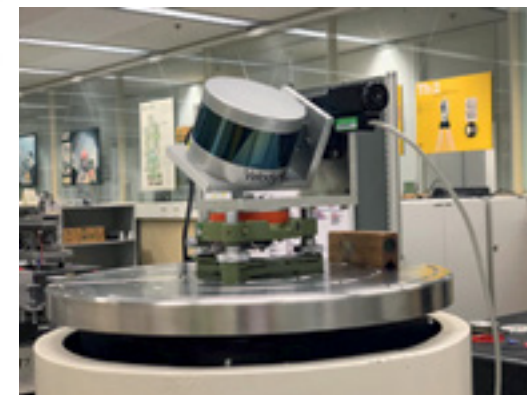

9

function independently in the event of a GNSS failure. With this in mind, the Institute is experimenting with relevant inertial navigation technologies. The current focus lies in the characterisation and modelling of MEMS sensors (micro-electromechanical systems), which are easy to integrate owing to their small size (< 1 mm). The ‘Ring Laser System’ is used as a reference and over the longer-term quantum sensors will be developed.

### LiDAR Systems

LiDAR systems (Light Detection And Ranging) are able to capture a three-dimensional environment. This makes it possible to create an environmental map or—by changing the measurement values—capture the relative motion of a user. LiDAR systems perfectly complement satellite navigation and inertial navigation due to their drift characteristic and are very often used in self-driving cars. In this exciting arena, the Institute is developing sensor error models as well as efficient processing algorithms.

### GNSS Software Receiver: Industry Leader

Software radio technology currently forms the basis of all research activities including the implementation of new GNSS receiver architectures or the design of sensor fusion between GNSS, inertial navigation and LiDAR. The GNSS software receiver developed by the Institute in 2003 remains a world leader in the industry. But it’s being developed now for use on a range of different applications which include a mobile robot platform, a self-driving car (tests on parking areas and snowy roads) as well as an app for centimetre-precise positioning on Android Smartphones.

### Autonomous Vehicles: Combatting Mispositioning

The Institute’s current research into self-driving cars is focused on avoiding mispositioning. Preventing mispositioning is clearly critical to ensuring safe driving conditions in the future. At the Institute,



10

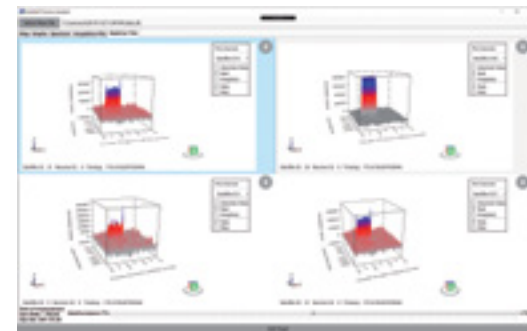

11



In addition to their teaching and research activity, the Institute organises the Munich Satellite Navigation Summit each year. This is an international conference with over 400 participants and top-class consultants from politics, the economy and science. Trends in satellite navigation, and hence the associated technical developments, are being discussed in cooperation with the European Commission and the Bavarian Ministry of Economic Affairs.

integrity tests used in the aviation industry are being adapted for this purpose and verified using statistical methods. Of course, the way in which satellite navigation will be used in autonomous driving is currently the subject of ongoing debate. Those favouring heavily regulated traffic control envisage the vehicle following a GNSS-defined virtual track (motorway driving). Those in favour of more flexibility envisage GNSS-informed artificial intelligence controlling the car.

GNSS can also be applied to quickly identify drivers travelling the wrong way down a motorway, inform that driver and warn other road users. With this

in mind, the Institute is developing methods that primarily focus on preventing false warnings.

### High Accuracy with Less Power

When using GNSS on a smartphone or for IoT (Internet of Things) data, a lot of concern surrounds power consumption. In this specific field the Institute is analysing the relationship between the time a receiver is in operation and the accuracy. Additionally, investigation is being conducted into installing several antenna elements into the smartphone itself so as to improve the reception—and thus power consumption. The antenna elements can be calibrated

online—so as to lead back to one, single point—and are inserted into the phone by means of simple metal plates. Harnessing Galileo, two frequencies can also be incorporated into the smartphone for positioning (1575 MHz and 1176 MHz), which—when deployed in conjunction with the appropriate algorithms—can massively enhance positioning accuracy.

### Infrared Interferometry for Unprecedented Resolution

Although GNSS reach extends from the earth's surface all the way to the lunar orbit, other navigation technologies lend themselves far better to space missions across the solar system. In this regard, the Institute is investigating a highly accurate relative navigation system made up of a constellation of five satellites, so as to create an infrared interferometer. A mission based on this technology would have the power to search for other solar systems and Earth-like planets with unprecedented resolution. Micrometre-precise distance measurements with frequency-comb technology would be used for this purpose.



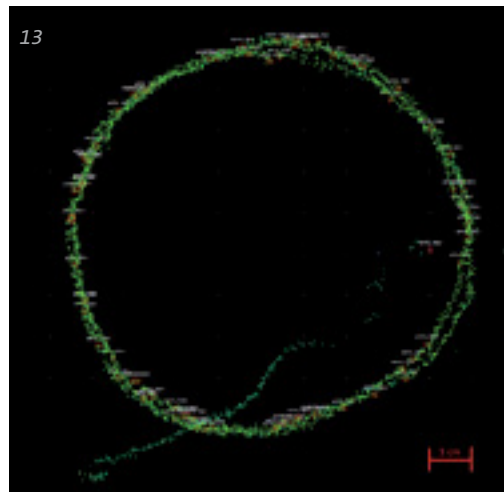

Figures 12 – 13

*Test setup and results for testing centimetre-accurate positioning with satellite navigation for future smartphones.*

## Asteroid Landings

Another research focus concerns the development of a navigation payload to safely land a space probe on an asteroid. By means of a fusion of LiDAR and inertial navigation, a map of the locality is created and evasive manoeuvres to larger rocks can be planned so as to achieve a safe landing as close as possible to the target destination. This payload can be validated via a UAV-based test system in an asteroid-like environment (volcanic landscape). Furthermore a more complex testing system can be created to correctly emulate the microgravity environment.



### **Univ.-Prof. Mag. Dr. Thomas Pany**

Institute of Space Technology & Space Applications

*Professor Thomas Pany heads up the Institute of Space Technology & Space Applications. His research team develops algorithms and prototypes within the field of Future Navigation Technology. With a primary focus on GNSS, the team work to come up with accurate and cost-efficient solutions in this exceptionally complex field.*



By Andreas Knopp, Christian Hofmann and Robert Schwarz

# The Role of Satellites in Secure Space Communications

Satellite communication is an integral part of the technological progress shaping a networked and digitalised world. This makes applications that use satellites in space for the purpose of communication ubiquitous—or everywhere! Satellites are perfectly designed to transmit signals over great distances by means of a single space-borne object. And cost efficiency is another compelling reason for usage. No wonder this form of communication has shaped modern society as we know it—the beaming of moving pictures into our living rooms is probably one of the most prolific examples.

But the application of communication satellites goes far beyond the mass media distribution known to the average person. Secure point-to-point connections may facilitate the transmission of live TV images across continents but they also establish mission-critical connections to overseas military bases or secure sensitive corporate networks. In a number of cases, a preference for satellites over classic Internet exists because protecting satellite connections from cyber attack is considered more efficient and reliable. Today, satellites enable voice and data connections reaching every point on Earth. Contemporary satellites can not only provide Internet connections in aeroplanes and on ships but also in terrestrially undeveloped areas. No wonder that in the newest 5G networks, satellite communication has recently attracted high attention—especially in the field of non-terrestrial networks.



---

Figures 1–2

---

*The versatile infrastructure of the Munich Centre for Space Communications includes fixed large-scale antenna farms as well as highly mobile car-based systems for broadband communications.*

The satellite industry is of huge economic and global significance. As a proportion of the entire aerospace industry—which is estimated to be around 320 billion euro in annual sales—roughly 75% comes from the satellite industry and its associated services and equipment. In fact, approximately every second euro spent is invested in some form of communication application—with satellite television broadcasting still accounting for the lion’s share or two-thirds of this revenue. Interestingly, the widespread circulation of Internet-based content and video-on-demand is starting to replace the classic offering associated with ‘linear television’. In general terms, the market for satellite-based solutions is growing steadily at approximately 3% per year. A large proportion of this comes from mobile broadband satellite applications as well as from the regulatory area of defence and mission-critical communication. Further growth is expected from the so-called mega-constellations, in

other words, gigantic networks of several thousand satellites in near-earth orbit, which are primarily intended for Internet applications.

The Federal Republic of Germany is home to a myriad of global market leaders and hidden champions that are dedicated to developing cutting-edge satellite technologies. A large concentration of these can be found specifically in southern Germany. And it is here, in Munich, that one of the most eminent research centres in secure infrastructure, satellite technology, satellite communications and ground station control has its base—and it’s part of the Universität der Bundeswehr München.

### **Satellites As Critical Infrastructure**

Satellites revolving in orbits between 500km and 36,000km above the Earth’s surface generate their

own source of electricity from solar panels and are therefore in autonomous operation. This means they can also be used as a means of communication over short and long distances if connections on Earth are unavailable—due to a power failure, for example. In the event of natural disasters or comparable catastrophes, satellite communication is quite rightly the backup of choice—making it the backbone of emergency communication.

Often crisis response requires large numbers of communication connections to be in places that lack sufficient terrestrial networks. Satellites are a flexible way to meet this need at very short notice. Emergency vehicles are increasingly equipped with satellite communication systems—making these vehicles themselves subject to protection—and assure a reliable communications channel is kept open during emergencies.

Figure 3

Under the banner 'A Day Without Space', simulation games can be played which are intended to illustrate the dependence of the modern world on space infrastructure and to raise awareness about its relevance for the cyber environment.

### Highly Vulnerable Objects in Space

Signals from a satellite that are sent back towards our planet as radio waves can either be distributed over the entire visible area of Earth or concentrated on surfaces spanning some 100km in diameter using strong directional antennas. The already substantial size of these reflector antennas makes bundling more waves together virtually impossible. That's why satellite signals are often located very far from their actual receiver, and can be intercepted and evaluated by third parties. Adequate encryption of sensitive data is essential in order to ensure a secure transmission. But it is still possible to work out the position of the transmitter and acquire other metadata such as frequency and scope of the communication using transmitted signals.

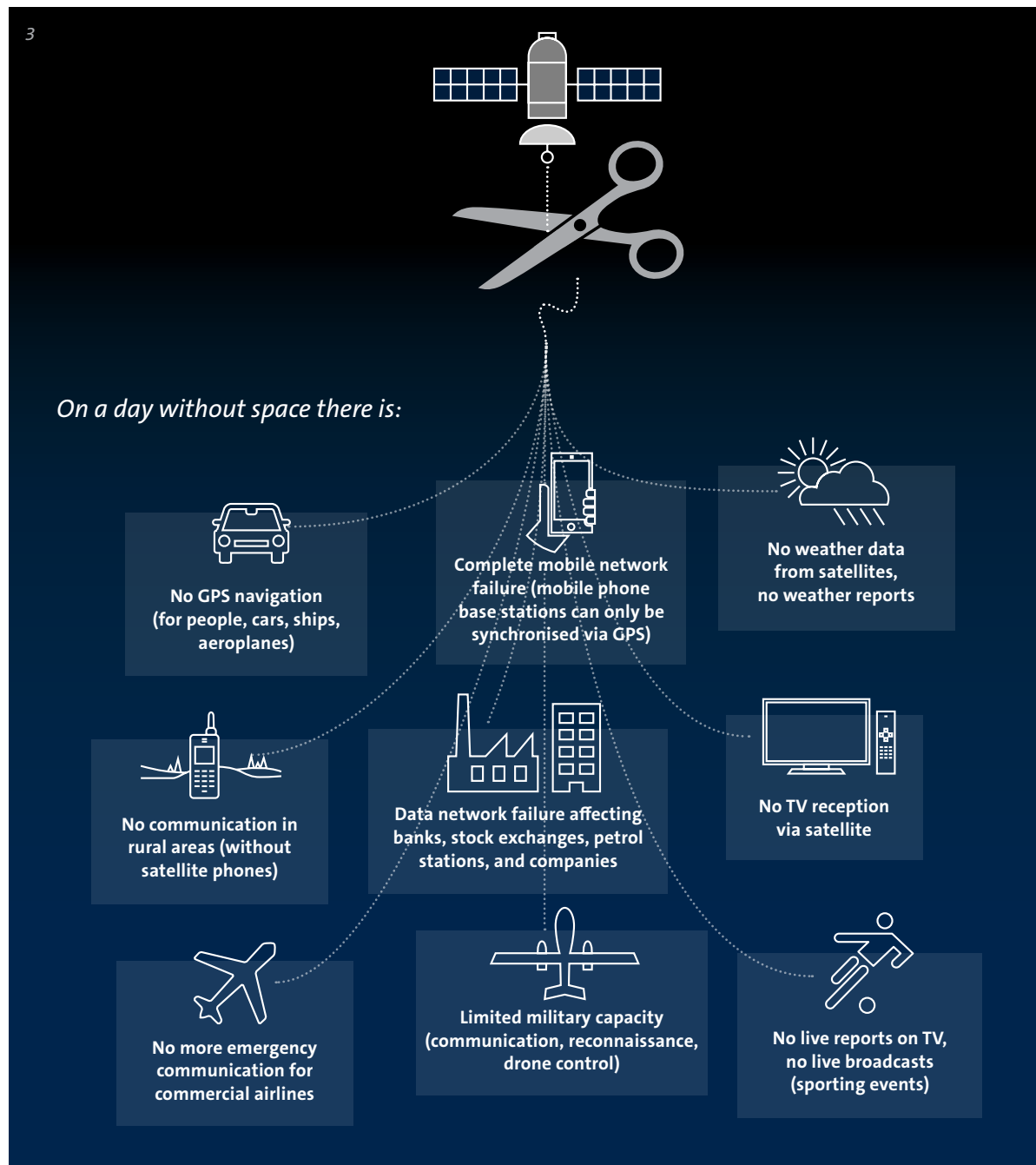



4



5



6



7

## » Attacks on satellite connections are commonplace in both military and civilian life.

left page · Figures 4–7

*The Munich Centre for Space Communications has first-class facilities for research on space communications. The satellite ground station has been designed exclusively for research and test purposes. Located in a secured environment, the station comprises the latest technology and fulfills military and government criteria as well as industrial requirements. The facility operates in all frequency bands relevant to satellite communications as of today, including military frequencies for large and small satellites as well as other high-altitude platforms. Its versatility with respect to the generation and reception of signals as well as the integration of hardware and software testbeds, software defined radios and third-party equipment, makes it a unique asset for multiple purposes like prototyping and testing as well as large measurement exercises and major field trials.*

The same conditions apply to radio signals that an object in space receives from Earth. A hacker who wants to intercept the connections using interference signals does not necessarily have to be near to a communicating user. They can be as far away as another country entirely where the interceptor is themselves protected from intervention threats. The threat of such hacker attacks is without doubt one of the greatest weaknesses of space-based communication. And it's why—depending on the importance of the transmission—it's best to minimise potential risks using technology, especially in the case of systems used for the military or government purposes. But there's a further challenge: Although there are many varied ways of doing this today, no method is one hundred percent secure. Which is why—in an effort to avoid cyber threats—the majority of recommendations concern increasing satellite complexity to make them harder for hackers to decipher.

Attacks on satellite connections are commonplace in both military and civilian life. An example of the latter is interference directed against Western TV content in Middle Eastern countries. The goal, of course, being

to obstruct freedom of information. At a military level, sovereign and military satellite connections are obvious targets for systematic destruction—curtailing important enemy communications. For this purpose, many states have dedicated interference systems which can immediately terminate insecure connections.

### **Extraordinary Research Institution**

The Munich Centre of Space Communications is part of the Institute of Information Technology in the Faculty of Electrical Engineering and Information Technology at the Universität der Bundeswehr München. And it now boasts first-class facilities for research on space communications. Over the past few years, there have been considerable financial and technological investments made towards developing and building a satellite ground station exclusively for research and test purposes. The ground station naturally fulfills military and government criteria that include the use of secure infrastructure and military frequency bands. With this experimental research facility now open, it's probably one of the most high-performance complexes of its kind in Germany and Europe.

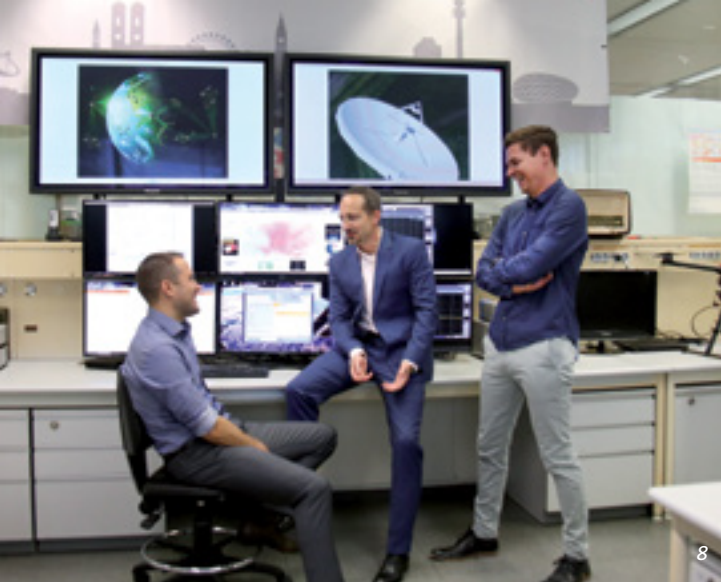

Figures 8–9

*The SpaceCom labs provide unrivaled capabilities for information transmission to outer space. Many hardware platforms and software tools have been developed for cutting-edge research and technology demonstrations.*

## Successful Suppression of Interference Signals

In addition to the latest satellite transmission technologies for the 5G mobile network of the future and state-of-the-art digital communication satellites, researchers at the University are now developing algorithms and methods to successfully identify and intercept interference signals. Scientists are aided by the trend prevailing in satellite communication of deploying an ever-greater number of fully networked antennas with increasingly small footprints. If interference signals are received by more than one antenna, it is possible to isolate the interference signal and improve the quality of the desired signal. The technology is tailored to the latest generation of modern communication satellites and enables, above all, mathematical methods of deciphering signals which lead to far better protection from interference.

The suppression of interference signals is also possible on the ground. An example might be a transmitter on Earth either intentionally or unintentionally interfering with a satellite reception system. However—in order to dimension the algorithms—information is required about the propagation of electromagnetic waves between antennas. The Universität der Bundeswehr München has successfully developed a complex measuring system that consistently provides core insights into signal propagation under specific conditions such as disruption or signal interferences.

## Experts for Multiple Antenna Systems in Satellite Communication

Multiple antenna technology (in short MIMO), has been subject to decade-long intense research at the Institute where it's attained a world-leading scientific position. MIMO—which is already a standard feature on Earth in the form of WLAN, LTE, and 5G—can

greatly enhance data throughput but is also perfectly suited to protecting communication systems from interception. An experimental radio system belonging to the Institute recently demonstrated the suitability of the procedure. In the meantime, patented solutions are being brought to market maturity by the Institute's doctoral students in a spin-off company at the University.

## Secure Internet of Things

In the Internet of Things a vast number of devices and sensors share data that is exchanged over an Internet connection. If these sensors transmit data via satellite connections (maybe because they're situated at locations without a terrestrial Internet connection), there's a high risk of unauthorised persons easily receiving such signals from numerous sensors. Even if the data itself is encrypted, sensitive meta information or the location of the sensors themselves



» In the Internet of Things a vast number of devices and sensors share data that is exchanged over an Internet connection.

are revealed in most cases. What is more, information security systems that use encryption are generally CPU-intensive and unsuitable for battery-powered miniature transmitters. In a mission to ensure that only authorised individuals can read signals from sensors or devices in the Internet of Things, the University is working on novel procedures that protect the transmission path. One such procedure now makes it possible to conceal signals deeply in noise and, thanks to ongoing efforts, definitively exclude unauthorised recipients intercepting them. At the same time, methods to support legitimate recipients in the easy detection of transmissions from many devices and to separate them from one another, are in development. This technology not only protects the content of a message but also makes the communication as such 'invisible'. The design also focuses on low-cost hardware—suitable for the mass market.



**Univ.-Prof. Dr.-Ing. Andreas Knopp MBA (l)**

Institute of Information Technology and Munich Centre for Space Communications  
*Andreas Knopp is the Chair Holder and Full Professor of Signal Processing at UniBw. Since 2016, he has headed the Munich Centre for Space Communications, which nowadays has emerged as a benchmark research institution in satellite and space communications technology with more than 10 sponsoring partners and three major research groups as of today.*

**Juniorprof. Dr.-Ing. Christian Hofmann (m)**

Institute of Information Technology and Munich Centre for Space Communications  
*Christian Hofmann is an Assistant Professor of Secure Space Communications, endowed by Europe's third largest satellite manufacturer, OHB. He heads a major research group at the Munich Centre for Space Communications, focusing on secure and efficient satellite-based IoT communications technologies and rapid hardware prototyping.*

**Dr.-Ing. Robert Schwarz (r)**

Institute of Information Technology and Munich Centre for Space Communications  
*Robert Schwarz is a Principal Scientist and Senior Lecturer of Space Communications Technology. He is the Laboratory Head of the Munich Centre for Space Communications. His research group focuses on satellite networks and system integration.*

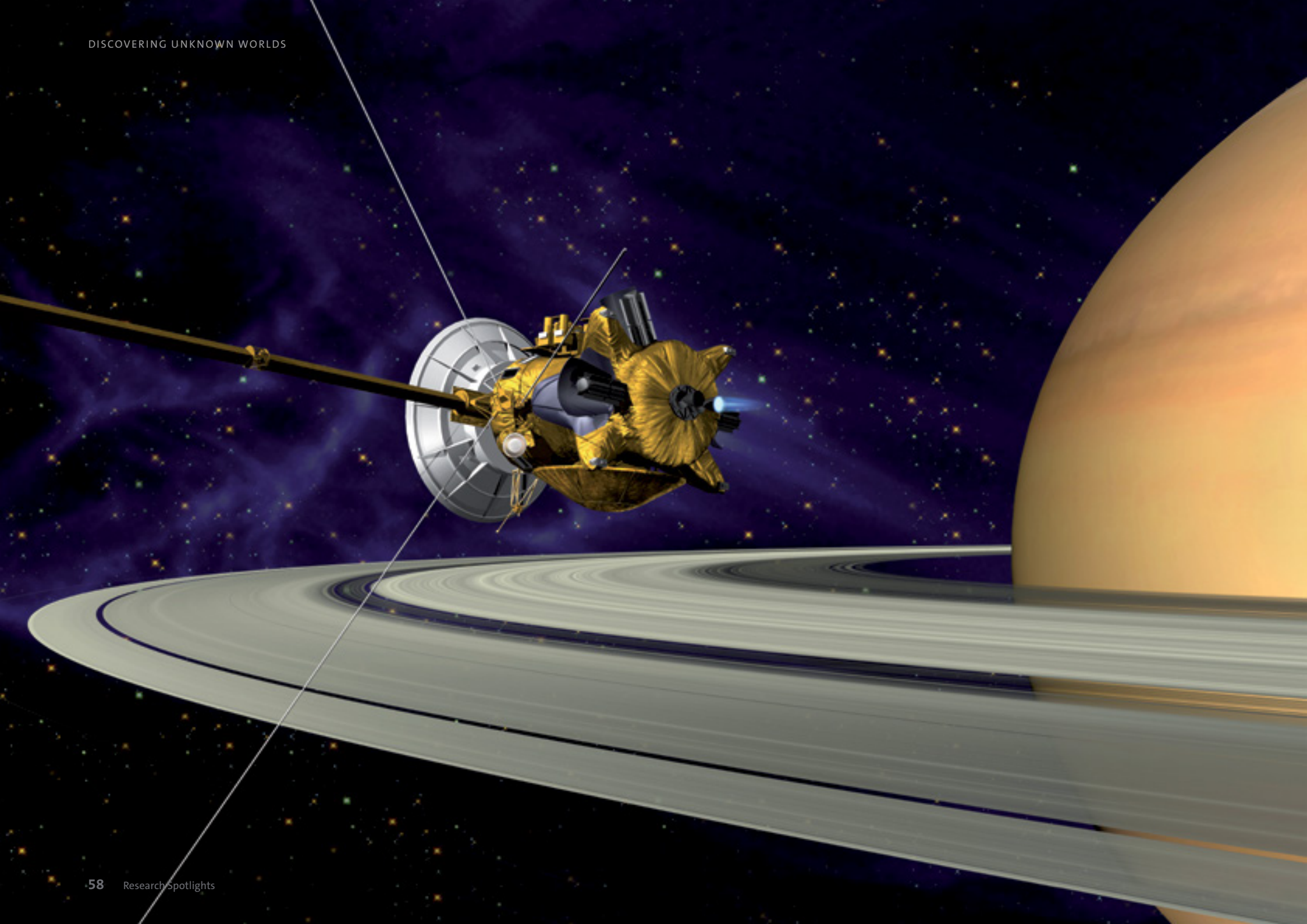

By Roger Förstner and Tom Andert

# Discovering Unknown Worlds

Contemporary life has seen us become more dependent, in a variety of ways, on space travel. Satellites for the observation of our Earth, for navigation and for communication have become essential to daily existence—even if many people underestimate the true extent.

Observation satellites enable us to monitor all corners of the Earth around the clock. Thanks to satellites, we gain a much better understanding of weather events, climate change and our natural environment than would otherwise be possible. Satellites are now such a critical feature in navigation that—without them—it would be impossible to imagine both the present and the future of mobility. And let's not forget that navigation satellites also provide us with time references upon which power supplies, mobile phones networks or financial trading rely. Imagine constant interruptions to these services?

Equally important are communication satellites, which connect the world. They represent a critical element in the successful digital transformation of society—holding the key to the fast and global transfer of data and information.

The increasing relevance of space travel for our modern society impacts how missions are executed at the technical and operational level. Topics such

∅ 1,392,684 km



∅ 4,879 km  
)← 57,909,000 km

Mercury

**BepiColombo**



∅ 12,103 km  
)← 108,160,000 km

Venus

**Venus Express**

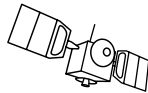

∅ 12,756 km  
)← 149,600,000 km

Earth

**REXUS/BEXUS  
& MIRIAM-2**

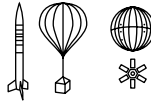

∅ 6,792 km  
)← 227,990,000 km

Mars

**Mars Express**

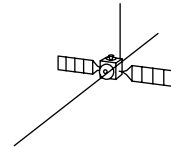

∅ 2 km  
)← 518,000,000 km

Churyumov–Gerasimenko

**Rosetta**

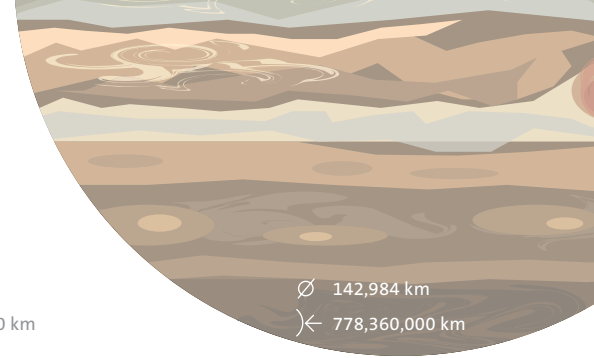
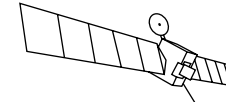

∅ 142,984 km  
)← 778,360,000 km

Jupiter

**JUICE**

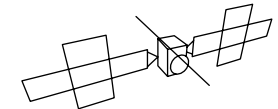

Sun

as series production, Industry 4.0, big data, artificial intelligence, micro- and nanosatellites, etc., play an increasingly crucial role and are already resulting in significant changes to the aerospace industry.

That said, space travel is synonymous with a certain detachment from Earth—the directing of perspective outwards into the depths of the solar system and outer space. Even today, in an enlightened world, space travel is about a fascination to explore the unknown. Space probes and telescopes make it possible to advance towards other planets, moons, asteroids or comets as well as to gaze through time and space across our universe. The knowledge we acquire helps us to better

understand the dynamics of our home planet, form hypotheses of what really might be ‘out there’ and get a sense for ‘the big picture’.

Missions to explore new worlds – the unknown – present space engineering with complex challenges. But somehow overcoming these barriers is part of the fascination with space technology research and development.

### Landing on New Worlds

For many years, the scientific world has asked itself the question of whether life exists on other planets and moons of the solar system besides Earth. In order to determine this, samples must be taken on site and investigated—with promising environmental conditions being those where liquid water is present.

It has now been confirmed that a liquid ocean does in fact exist under a kilometre-thick layer of ice on Saturn’s moon Enceladus. The ice shield of this icy moon exhibits cracks and geysers made of water or frozen water, which opens up the possibility of taking samples without having to penetrate the kilometre-thick layer of ice. Enceladus is, therefore, a high priority target when searching for life beyond Earth.

One of the greatest challenges surrounding a mission to Enceladus is the need to land autonomously and precisely on very difficult terrain. Supporting the German Aerospace Agency (DLR) with its research project ‘Enceladus Explorer’ (EnEx), the Institute of Space Technology & Space Applications at the Universität der Bundeswehr München is examining how such a mission might technically be feasible.

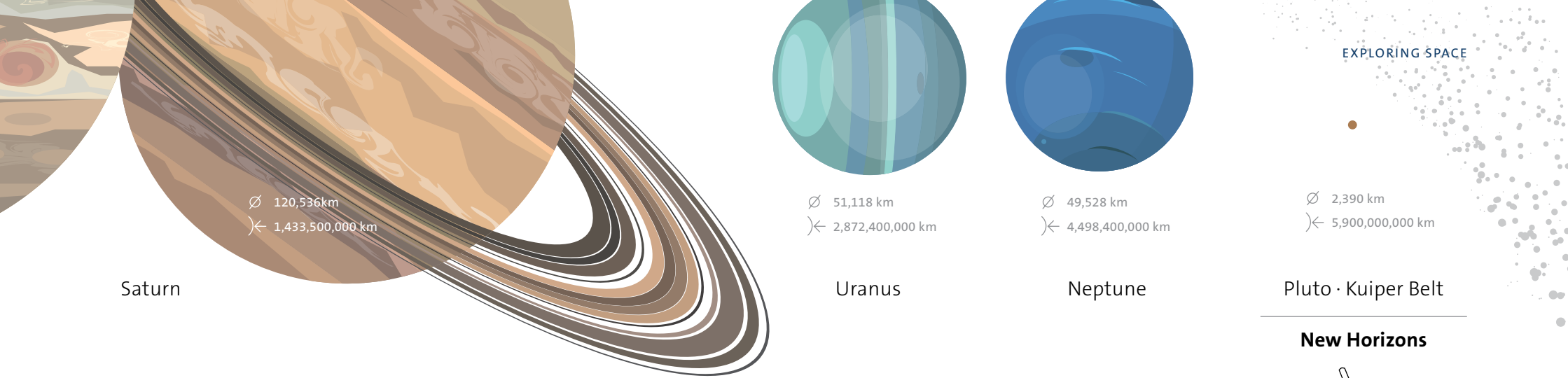

Saturn

Uranus

Neptune

Pluto · Kuiper Belt

### New Horizons



Figure 1

The Institute run by Professor Förstner has deep experience of real space missions to many planets and small bodies (comets, asteroids) in the solar system. These missions are visualised above.

The size of the planets and the sun are drawn to scale (the distance between them not).

Owing to the position of the geysers, any landing would have to take place in a narrow valley in darkness, precisely at the edge of the cracks in the ice. This gives rise to a number of complex challenges, for which different solutions are being developed.

First, a variety of different sensors are required—making it possible to generate all the data necessary to perform a safe landing. Since it is very dark within the valley, optical cameras cannot be used for the final approach and landing. Showing the most potential

for the approach and landing is the LiDAR sensor (Light Detection And Ranging)—which works much like a radar other than the fact that it uses laser light instead of radio waves. Given that it is an active sensor, it can even record its surroundings in complete darkness. Another important sensor is a thermal camera—which can capture the heat radiation of the geysers via infrared and in so doing identify the landing point position near the geyser. Finally, another essential tool is the Inertial Measuring Unit (IMU). This is employed to measure the movements of the space probe during the landing both translationally and rotationally.

Because Saturn’s moon Enceladus is up to 1.6 billion kilometres away from Earth, it takes a radio signal approximately 1.5 hours to reach Enceladus from Earth or Earth from Enceladus. For this reason, the space probe cannot be directly controlled from Earth.

In other words: The landing on the icy moon must be completely autonomous. This demands close analysis of the actual environment, detecting hazards and identifying possible landing sites. Once that’s done, it can be decided which landing place should be approached on which trajectory. Given that the actual situation on the ground is detected with a higher level of detail as the space probe gets closer to the surface, it might also be necessary to change the plan at short notice and approach a different landing site altogether. And let’s not forget that this entire process is happening autonomously!

The unique conditions described here pose a major challenge to the deployment of classic navigation and flight guidance software. What is more, solutions need to be robust enough to deal with a high level of uncertainty. This calls for more innovative methods of computational intelligence (ranging from image

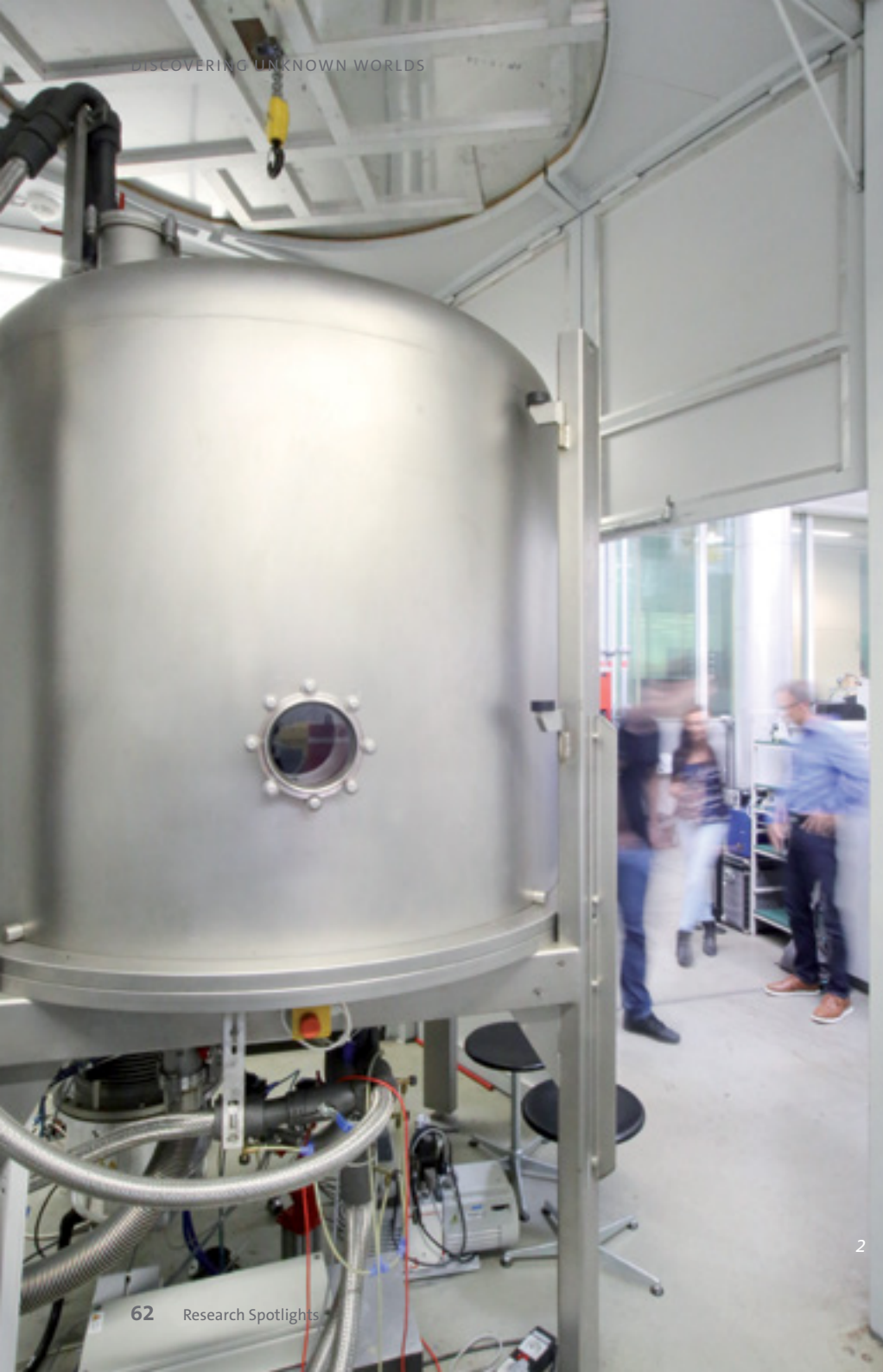

2



3



4

The Institute has several laboratories and equipment for conducting different tests and experiments. For example: A thermal vacuum chamber (2), a cube sat (3) and a shaker system (4).

processing, sensor fusion, pattern recognition, and decision making). And naturally opens investigations up to broader areas of research—making the dream of one day exploring our solar system with robotic space probes that operate with full autonomy a reality. But many details still need to be cleared up first. The sheer distance and number of technical limitations make error correction incredibly difficult.

At the Institute of Space Technology & Space Applications scenarios are being tested and simulations have demonstrated that it might be possible to carry out an autonomous landing under very difficult conditions by applying basic computational intelligence algorithms. The goal now is to top the current success rate of approximately 94% through the use of hardware-in-the-loop and model-in-the-loop tests and by applying more complex computational intelligence algorithms.

In so doing, the Institute of Space Technology & Space Applications is playing a significant role in developing key technology that stands to make new worlds accessible in the future. And provide fresh scientific knowledge as to the origin and development of our solar system.

Rosetta at the Churyumov-Gerasimenko comet (5). The Institute is involved in several current and future space missions such as New Horizons (6) and JUICE (7).

### Radio Sounding of New Worlds

Every space probe has a communication system used to transmit scientific data to Earth or receive ground control command sequences. With the help of radio science technique the communication system can also be used as a scientific tool to investigate new worlds such as planets, asteroids, and comets in our solar system. To this end, a radio signal—in other words, an electromagnetic wave with a frequency in the range of several GHz—is transmitted from the ground station on Earth to the space probe, received and then transmitted back to Earth. The ground station records data such as the time, frequency and amplitude of the signal. A change of signal frequency can be triggered by the small movements of the space probe. It's a phenomenon known as the 'classical Doppler effect' and it occurs, here on Earth, when an ambulance drives past with a siren on. As it passes, the siren changes in pitch—brought about by the relative change in velocity to the observer. And the same applies to a radio signal passing through a medium such as a planet's atmosphere—which triggers a change in frequency or amplitude. In fact, a simple reflection of the radio signal on a planet's surface can also change the amplitude and polarisation of the signal.

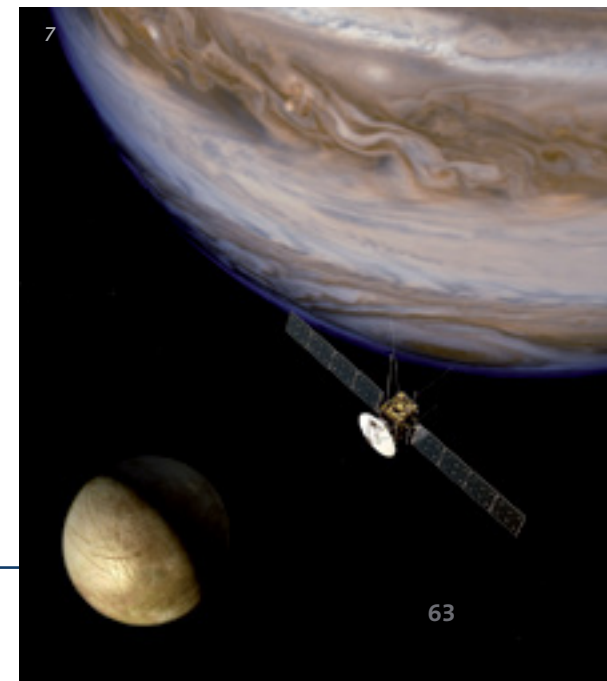

## Gravity and Interior Investigation

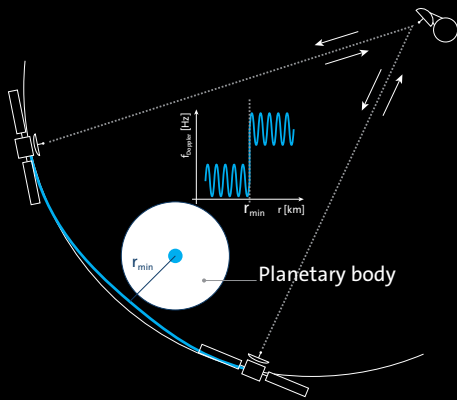

## Bistatic Radar Surface Investigation

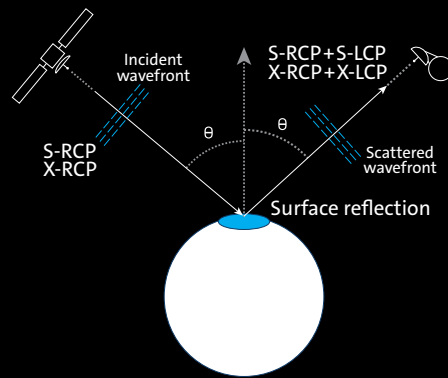

## Atmospheric and Ionospheric Sounding

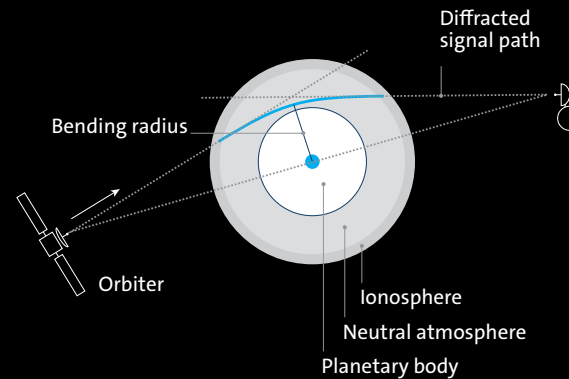

## Solar Corona Investigation

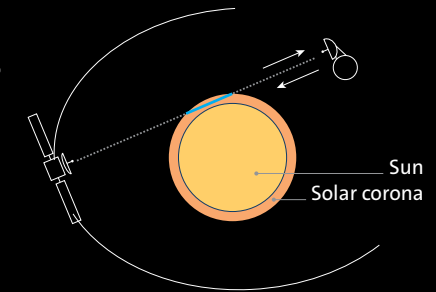

8

Radio science technique studies a number of scientific aspects concerning planets, asteroids, and comets (Figure 8). These include:

- Atmosphere and ionosphere
- Properties of rings and surfaces
- Mass and internal structure
- The Sun's plasma environment

The complexity of data evaluation is much increased by numerous different contributions that result in changes to observational data. An example of this might be the change in frequency due to the Earth's atmosphere. Another major contribution is made by the radio signal being transmitted from the Earth, to the space probe and back again—moving through interplanetary space. This can take up to nine hours if the space craft is at Pluto, for example. It stands to reason that these contributions need to be individually distinguished.

And that each one's influence then predicted using models set up in the evaluation software. These have to be made with an accuracy of less than 1 mHz at 8.4 GHz. This is the equivalent of measuring the route from Munich to Hamburg (some 600km) with an accuracy of less than 1  $\mu\text{m}$  (the thousandth part of an mm). In order to achieve this level of accuracy, effects such as the movement of the ground station due to solid tides (in the range of 10 cm) are taken into account for the evaluation. Stringent requirements are also placed on the frequency stability of a radio signal, which is achieved in the ground station using hydrogen masers, and onboard the space probe with an ultra-stable oscillator.

In the case of so-called bistatic radar measurements, the space probe is rotated so that the antenna points in the direction of the specular point (Figure 8 second

illustration from left) on the surface of a planet, asteroid or comet and follows this point throughout the entire measurement period. In September 2014, a bistatic radar measurement was carried out for the first time ever on an object as small as the Churyumov-Gerasimenko comet (Figure 5). Preparation work for measuring was carried out at the Institute of Space Technology & Space Applications at the Universität der Bundeswehr München in cooperation with the the European Space Agency (ESA). The specular point on the surface is defined

Figure 8

*Radio sounding can be used to study a number of scientific elements concerning planets, asteroids, and comets.*



»» Even today, in an enlightened world, space travel is about a fascination to explore the unknown.

such that the radio signal's angle of incidence is equal to the angle of reflection. If you look at the shape of the comet, it is clear that this planning posed quite a challenge. The space probe, comet and ground station also move relative to one another in the solar system. The first measurement took place in late September 2014. For the measurement, one of the three large 70 m ground stations belonging to NASA was used over a period of several hours. When the space probe began to rotate its antenna towards the comet, the radio signal—which was transmitted from the space probe—disappeared as expected from the display. This led to many minutes of tense waiting. Were the calculations and simulation for the measurement over the past months correct? After 20 minutes, the longed awaited reflected signal that was sent from the Rosetta antenna to the surface of the comet appeared; it had travelled almost 450 million kilometres through the solar system to reach the ground station on Earth.

These examples show how fascinating the work of the Institute of Space Technology & Space Applications is when it comes to exploring new worlds using radio science technique. Spurred on by the potential of new technologies, the Institute continues to be involved in a number of ongoing missions that include Mars Express, New Horizons and future missions such as that from the European Space Agency ESA to Jupiter (JUICE) and that from NASA to various asteroids (LUCY).



**Univ.-Prof. Dr.-Ing. Roger Förstner**

Institute of Space Technology & Space Applications

*Professor Roger Förstner worked for several years in industry, where he was a member of a systems engineering team responsible for the development of deep space missions. In his lectures he combines theory and practical space engineering inspired by his own industrial experience.*

*As Head of the Institute of Space Technology & Space Applications, Roger Förstner is responsible for research in the area of innovative mission concepts and new technologies and supports planetary missions through the development and execution of radio science experiments.*



By Christian J. Kähler and Sven Scharnowski

# The New Way to Outer Space

Satellites orbiting our Earth accompany us as we go about daily life. We need them to navigate, communicate, to forecast the weather, and for the surveillance of operations on Earth. But we also need them to expand our fundamental knowledge of the Universe. Transporting satellites into the Earth's orbit requires extremely powerful space launchers. For providers of space launching technology, increasing the power of the launchers whilst cutting costs is an ongoing challenge.

At the Institute of Fluid Mechanics and Aerodynamics, a new propulsion nozzle concept is currently being investigated that could create new forms of value for the space systems of the future. It's the Institute's objective to significantly improve the reliability and efficiency of existing space launchers. And the research is expected to make a major contribution to the cost-effective, sustainable and safe transportation of satellites into space over the years to come.

## **Overcoming Gravity**

Powerful space launchers—such as the European Space Agency's (ESA) Ariane 5—are needed to overcome the tremendous force of gravity and successfully launch satellites into orbit. Rocket engines generate the thrust required to ascend by burning fuel in the combustion chamber and then

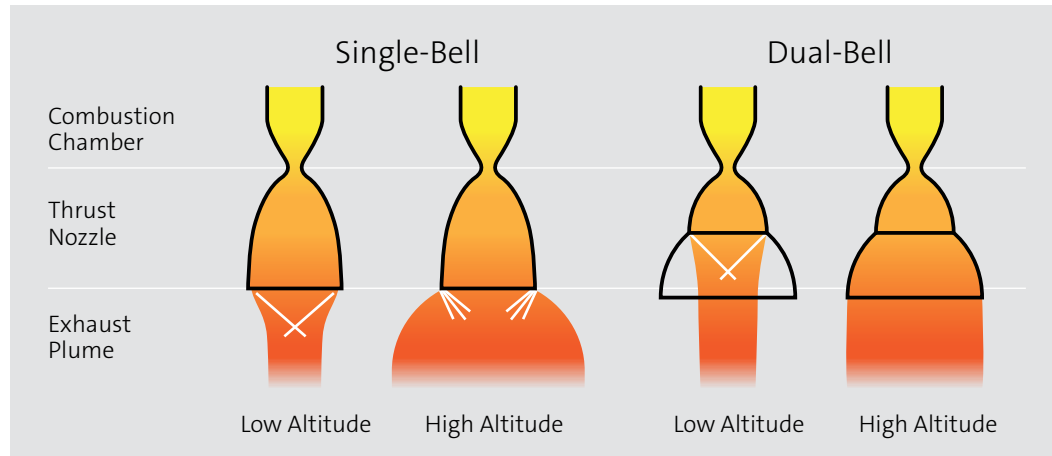

---

Figure 1

---

*The different states of a single-bell and a dual-bell thrust nozzle during ascent into the atmosphere.*

accelerating the exhaust gases through thrust nozzles. The Ariane 5 requires approximately 660 tonnes of fuel for ten tonnes of payload, which corresponds to the weight of two larger satellites. Liquid hydrogen and oxygen drive the main and upper stage of the space launchers. To enable the launch, two additional solid fuel boosters need to be fixed to the side of the space launchers, which generate the majority of thrust during the first 100 seconds.

### Conventional Nozzle Geometry

Due to high pressure in the combustion chamber, exhaust gases are accelerated in the nozzle and reach sonic speed at the narrowest point. After this, the cross section expands into a bell-like shape, which creates supersonic flow. The acceleration of the gas velocity in the supersonic range is primarily a result of the strong decrease in gas density. In contrast with

subsonic nozzles, where a cross section reduction causes an acceleration, supersonic nozzles need to be expanded in their cross section to accommodate the expansion of gas. When the exhaust gases exit the nozzle, they adapt to the ambient pressure. Since pressure in the atmosphere decreases the higher above ground travelled (space is a vacuum), pressure dropping during an ascent into the atmosphere poses a major challenge. That's because while the propulsive jet is compressed due to large ambient pressure at low altitudes, it expands considerably in thinner air layers at higher altitudes. This alters the thrust and therefore the entire aerodynamic behaviour in the tail section of the rocket. A nozzle with an adjustable surface ratio or adjustable combustion chamber pressure would ultimately ensure optimal performance at all times. But such a nozzle is technically impossible because it's both thermally and mechanically loaded to the maximum.

### Advantages of the Dual-Bell Nozzle

In contrast to conventional thrust nozzles, the dual-bell nozzle consists of two 'bells' that merge into one another via a contour junction. The contour junction enables a defined separation of the nozzle flow at high ambient pressure, as shown in pressure (Figure 1). At low atmospheric pressure, the second nozzle extension is also filled. This means that during ascent, the jet area of the nozzle can be adapted without making actual mechanical changes. The nozzle then switches automatically as soon as the pressure has subsided enough.

### Testing Spacecraft on the Ground

Experimental studies in wind tunnels are essential for the development of new nozzle concepts. For several years, the Institute of Fluid Mechanics and

» The Ariane 5 requires approximately 660 tonnes of fuel for 10 tonnes of payload, which corresponds to the weight of two larger satellites.

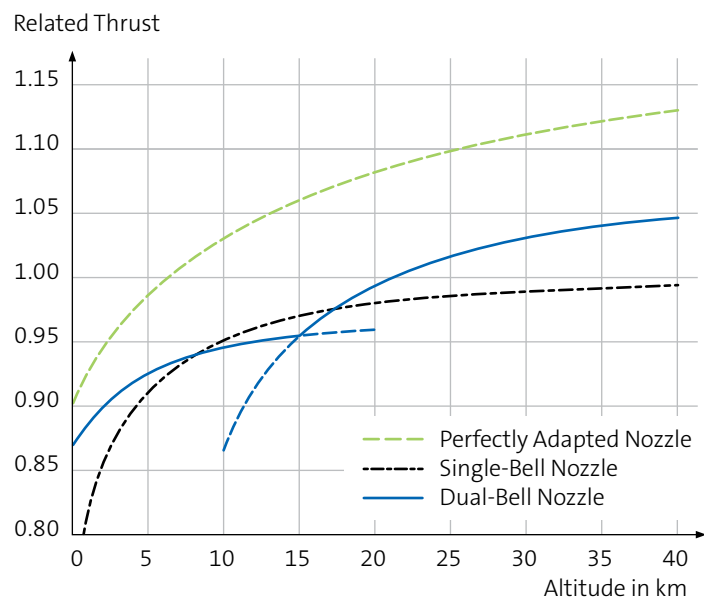

Figure 2

*Thrust for a perfectly adapted nozzle compared to a real thrust nozzle with a single-bell and to a dual-bell nozzle.*

Aerodynamics has been investigating interactions between the nozzle exhaust plume and external flow as part of a German Research Community (DFG) project (SFB-TRR40). For this purpose, a generic space launcher model has been designed and manufactured which visualises the essential flow effects. The generic rocket model is equipped with a planar dual-bell nozzle that is operated with dry air. The results of the planar nozzle are then later converted across to a round nozzle like those used in a real space launcher.

In the test section of the Trisonic Wind Tunnel Munich (TWM), the most important areas of the rocket ascent can be simulated. The TWM enables external flows in the Mach number range of  $Ma = 0.3$  to  $Ma = 3.0$ —in other words—flow velocities of up to three times the speed of sound. For the aerodynamic evaluation of the rocket base flow, it is important to examine the entire Mach number range. The range around the sound

barrier ( $Ma = 1$ ), is particularly critical in the case of a real rocket launch as the aerodynamic loads are largest during this flight speed.

### Sea-Level Mode and Altitude Mode

In the first phase following the rocket launch, the dual-bell nozzle is in sea-level mode. This means there is a full flow happening through the inner bell which is then separated at the contour junction to the outer bell. This results in a relatively small surface ratio and optimal thrust can be achieved in a still dense atmosphere. The external flow continues to be subsonic under these flight conditions.

At approximately 6 km in altitude, the ambient pressure falls to half the pressure at sea level and shortly afterwards Ariane 5 reaches the speed of sound. Pressure then drops due to an expansion of

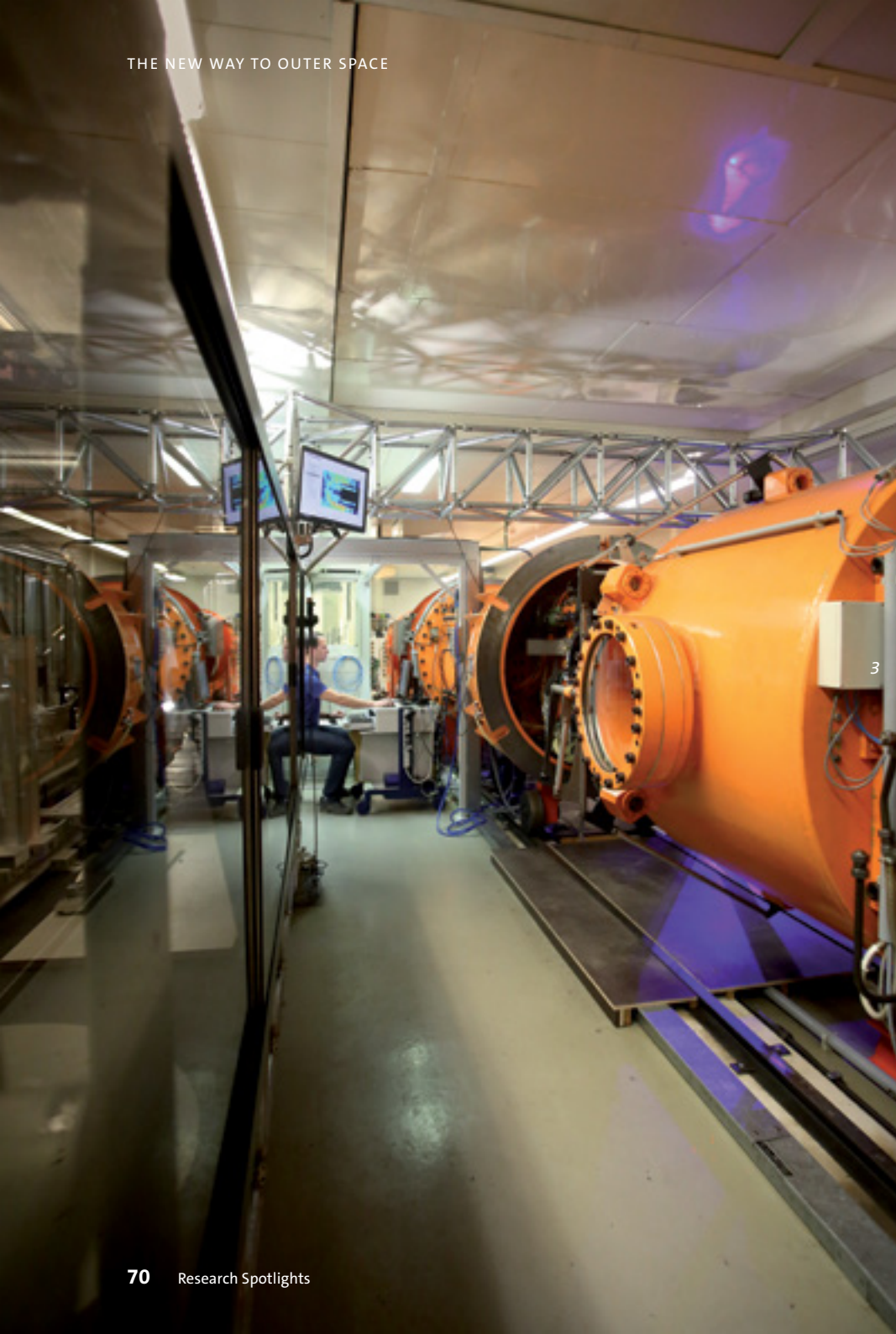

---

 Figures 3–8
 

---

The Trisonic Wind Tunnel Munich (TWM) is a blowdown facility that releases pressurised air into the atmosphere. With two freely adjustable throats, the laval nozzle and the diffuser (3, 6), a Mach number range of 0.3 to 3.0 is achieved.

In the holding tanks 8 tonnes of dried air is stored (8), which is then emptied during a test at up to 240 kilograms per second. The test time is 30 seconds with highest mass flow at a Mach number of 1 and reaches around 100 seconds in subsonic and supersonic conditions. The massive noise generated during a test run is countered with a silencer in the exhaust tower (6) and soundproof walls inside the hall (5).

A generic space launcher model with thrust nozzle and connections to the air supply (7) is mounted to the sidewalls of the test section (4) for the experiments.

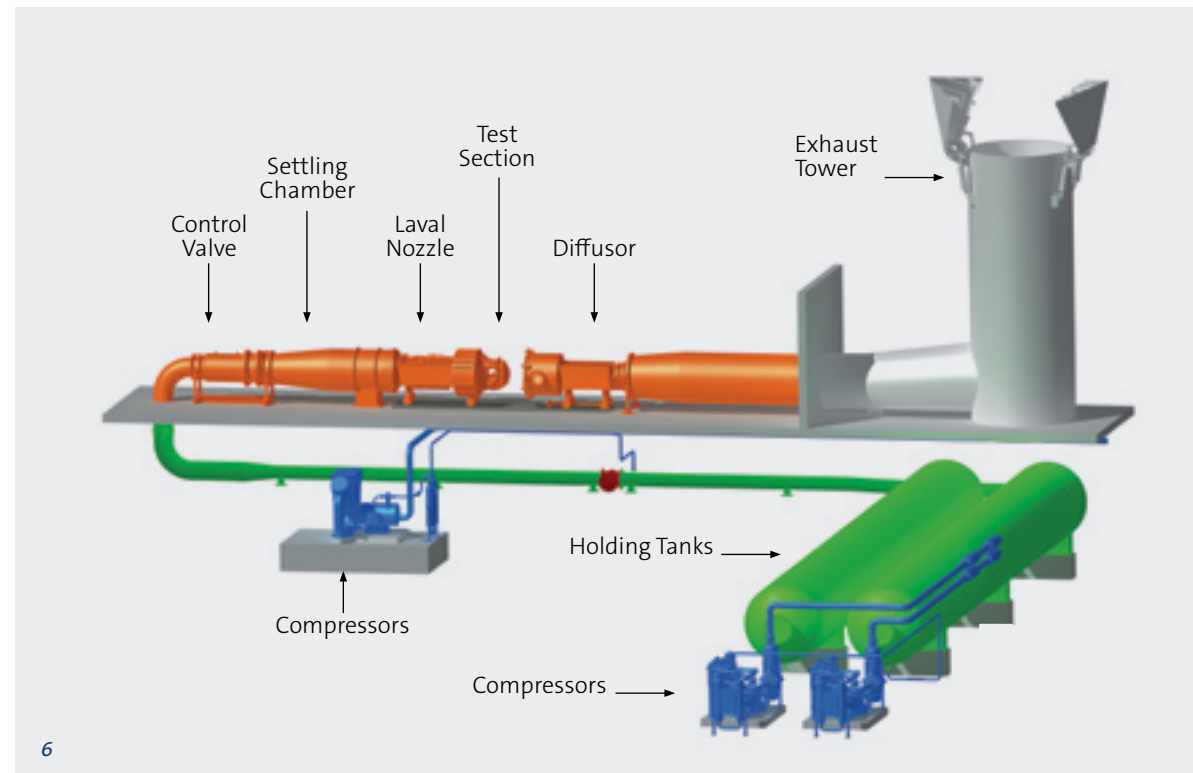

6

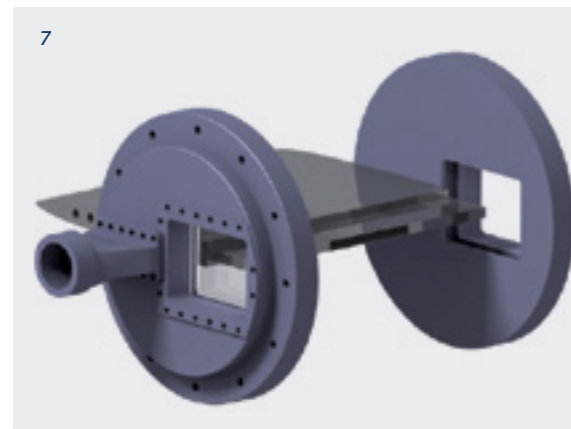

7



8

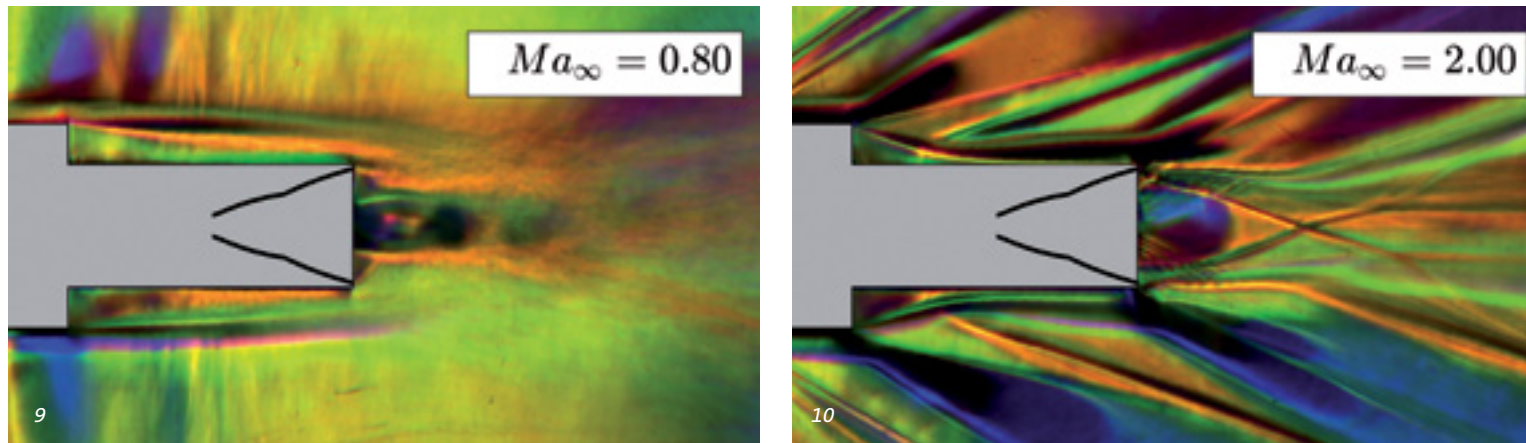

---

Figure 9–10

---

*Images of the wake flow of a generic space launcher with the two modes of a dual-bell nozzle: sea-level mode with separation at the contour junction (9) and altitude mode with fully blowing nozzle (10).*

the supersonic flow at the rocket's base. Due to the reduced pressure, the outer bell in the dual-bell nozzle fills as well and the nozzle operates in the so-called altitude mode.

At what height—or better said, what pressure—the dual-bell nozzle should switch to altitude mode, largely depends on the external flow. This means that design of the outer geometry cannot happen in isolation of the design of the nozzle. Wind tunnel tests can help to understand this complex interaction

and make it possible to explore engines before they are built and put to the test. This not only reduces costs and minimises potential development risk, but also makes it possible to systematically analyse innovative high-promise concepts.

## Outlook

The dual-bell nozzle seems a very suitable answer to increasing the efficiency of space launchers. But there is still a lot more work to be done. Before any satellite can actually be transported using this innovative nozzle, a few fundamental questions need to be answered. For example, in addition to the aerodynamic integration and thermal management of the new nozzle, the optimal time for the transition from sea-level mode to altitude mode should be determined. While the dual-bell nozzle autonomously

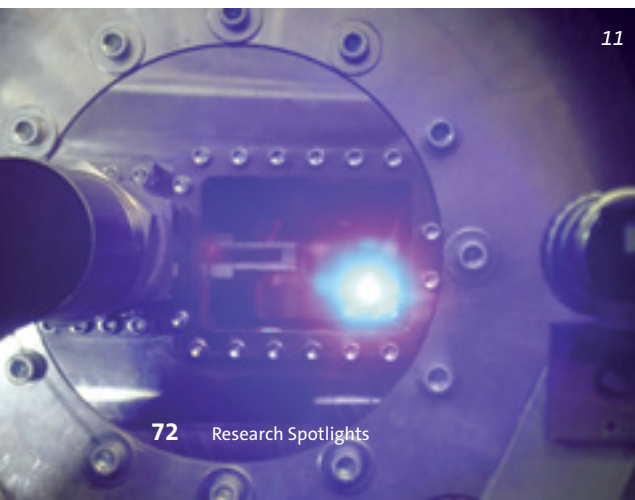

---

Figure 11

---

*Space launcher model as seen through the wind tunnel test window. Visible in the foreground is a nozzle supplying a flow of air and in the background a schlieren illumination.*



» The nozzle flow and the outer flow strongly interact with each other and influence the space launcher's aerodynamics significantly.

switches from sea-level mode to altitude mode, when that actually occurs is dictated by the nozzle's geometry, external pressure and the Mach number. In other words, the shape of the nozzle also determines the switching behaviour.

When switching from sea-level mode to altitude mode, a pressure wave runs through a second nozzle bell. This causes considerable mechanical stress. For the dual-bell nozzle to operate safely, it is essential that this transition only takes place once. Multiple switching between both modes would destroy the thrust nozzle causing the space launcher to crash. In order to avoid multiple transitions, the external flow must be taken into account: And it's exactly that element of an already highly complex technology this is the subject of current research at the Institute of Fluid Mechanics and Aerodynamics.



**Univ.-Prof. Dr. rer. nat. Christian J. Kähler (l)**

Institute of Fluid Mechanics and Aerodynamics

*Professor Christian Kähler is Head of the Institute of Fluid Mechanics and Aerodynamics. In this capacity, he conducts research into complex flows in the macroscopic and microscopic ranges with non-contact imaging measurement methods.*



**Dr. rer. nat. Sven Scharnowski (r)**

Institute of Fluid Mechanics and Aerodynamics

*Doctor Sven Scharnowski works at the Institute of Fluid Mechanics and Aerodynamics examining compressible flow at the Trisonic Wind Tunnel Munich (TWM).*



The emissions we release into the atmosphere are changing our climate for good. At the same time, mass urbanisation and population growth is putting pressure on essential resources like water. How we combat these problems is key to protecting **tomorrow's environment**.

76

**Future Ready: Sustainable Urban Water Management**  
Christian Schaum

84

**A Healthier Atmosphere: How Measuring Particles and Gaseous Pollutants Helps**  
Thomas W. Adam

92

**CO<sub>2</sub>-Neutral Mobility: From New Fuels to Innovative Combustion Processes**  
Christian Trapp







By Christian Schaum

# Future Ready: Sustainable Urban Water Management

Effective urban water management promotes basic hygiene and sanitation standards, seeks to protect both surface water and groundwater, and preserves additional resources used in the process. It's a critical component of modern civilisation. Access to safe drinking water and sanitation is one of the basic human rights laid down by the United Nations. And for good reason: Approximately 2.6 billion people worldwide still have no access to basic sanitary facilities. And each day some 3,900 children die as a result of poor hygienic conditions, cf. UN (2012). No wonder water can be the source of conflicts and refugee dispersion.

Referring back to its commitments in 2015, the United Nations has now defined the 6th goal of the Agenda 2030 for sustainable development as being: 'To ensure the availability and sustainable use of water for everyone.' But this is easier said than done. Climate change represents a significant threat to the sustainable use of water and wastewater. And future-proof concepts can't be developed behind fences. Contemporary urban water management is an issue spanning borders.

The sustainable use of water—both now and in the future—is one of the most important issues of our time. Water is a vital resource not just for drinking, but also for irrigation in agriculture, for industrial processes or in energy generation as a coolant. If we observe water management processes, we see a number of other resources leveraged along the way. In the provision of drinking water, wastewater disposal and waste treatment—for example—energy is required to power pumps and processing

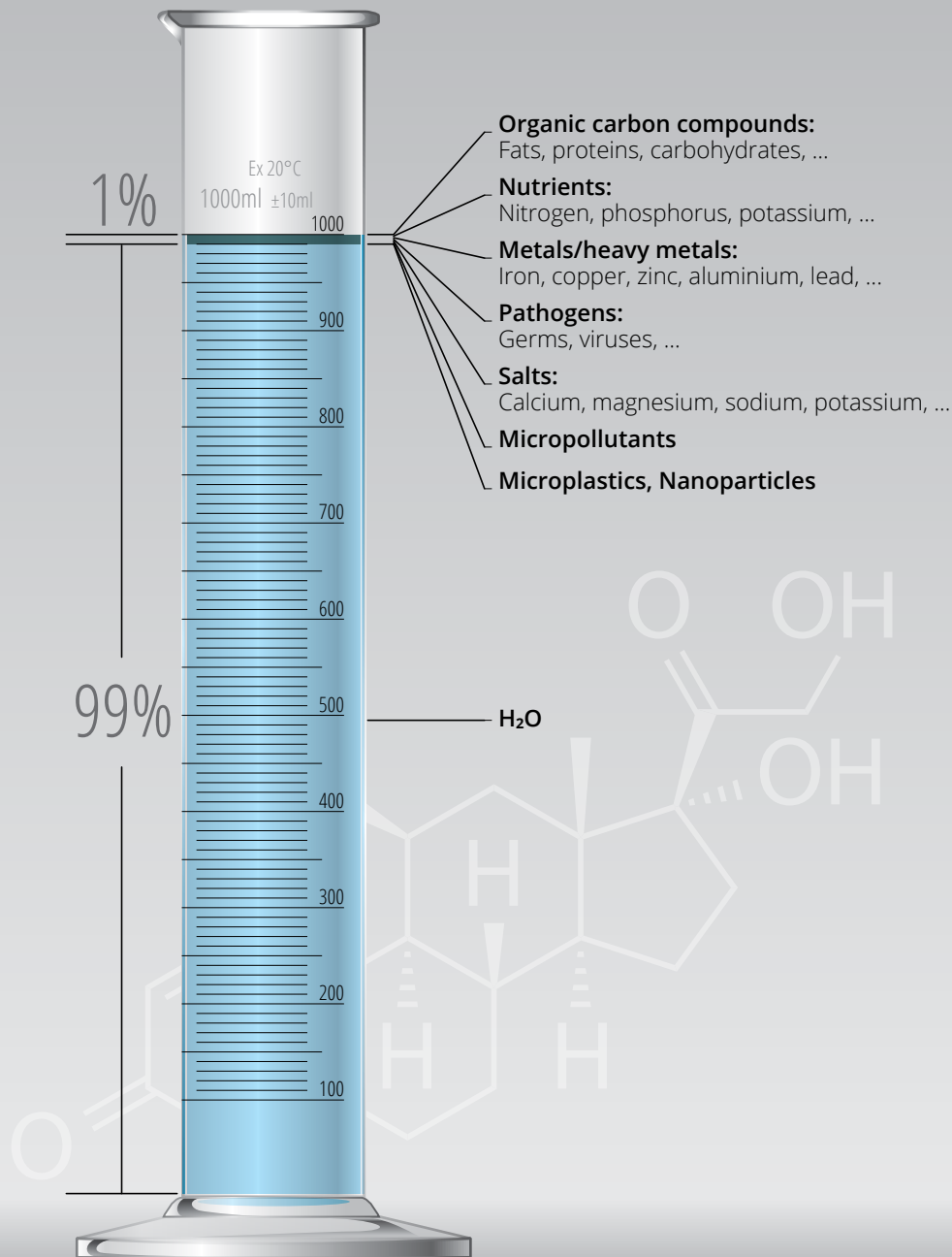

technologies. In fact, wastewater, itself, also contains resources such as nutrients and energy, which have the potential to be put to better use. (Schaum, 2016)

The Universität der Bundeswehr München presents as a familiar academic face in research-based consulting of local and national governments regarding critical infrastructures, wastewater, modern piping systems, water reuse, and the application of sewage sludge among other topics. The team have spent more than 10 years researching potential improvements and dangerous vulnerabilities that shape any discussion about the future of water management.

### Critical Infrastructures

Any plant responsible for the continued supply of drinking water and sewage disposal/treatment is classified as a critical infrastructure. These are essentially facilities of great importance to the national community, whose failure or impairment would cause long-term supply shortfalls, serious disruptions to public safety or other dramatic consequences. (BMI, 2009) In this regard, facilities face very specific challenges in terms of ensuring the supply of drinking water during (long-lasting) power failure, environmental catastrophes, IT system failures and serious malfunctions of the plants themselves.

Figure 1

*Even when wastewater contains a large number of additional substances, that wastewater will still consist of 99% water.*



---

 Figures 2–4
 

---

*Since wastewater is a multi-component mixture, it requires the use of different methods for sample preparation and analysis.*

Appropriate guidelines facilitate the development of concepts aimed at supporting local communities in providing planning and crisis management. (Broß et al., 2019)

### **Wastewater – A Mirror Image of Our Daily Water Usage**

Even though wastewater is still 99% water, it contains a mixture of numerous chemical compounds with which we come in contact on a daily basis. It also contains a number of micropollutants, such as medication, their degradation products, nanoparticles or microplastics.

In most large cities around the world, modern society is threatened by organised crime that includes the illegal drug trade and terrorist movements. Both these forms of criminality leave their chemical mark

on urban water supplies. The laboratories used for manufacturing drugs and explosives are commonly located in disused urban buildings. Manufacturing both substance groups results in contaminated wastewater that naturally enters the public sewage system. These days, there are now specialist substances that can be pumped into the wastewater system and used to detect such discharges as well as ultimately locate where such illegal laboratories are (SYSTEM research project). As things stand, however, many of these additional chemicals are simply allowed to run into the wastewater system.

### **Modernising Wastewater Piping Systems**

Your average city dweller is not remotely aware of the sewers or drinking water pipes that ensure their daily sanitary needs are met. They are laid underground, of course. But city administrators and planners cannot

afford to lose sight of the significant role this labyrinth of systems plays in our modern society. Preserving these systems represents an ongoing mission. Evolving conditions, such as demographic change and climate change, make it necessary to structurally adapt piping systems. And this should also go hand in hand with new ways of exploring maintenance cost efficiencies. In some regions—such as those in southern Germany, where there are many small-scale settlement structures—cost-efficient concepts for planning are required that harness inter-municipal cooperation. (Krause, 2017)

### **Reusing Water: From Wastewater to Bathing Water to Drinking Water**

Today's wastewater treatment plants go far beyond the widespread image of traditional sewage treatment plant—or what used to simply be a technical system





## » Microplastics are plastic particles <5 mm, and their presence everywhere makes them the focus of science, political and societal debate.

for treatment ('clarifying') wastewater. Modern wastewater treatment plants have far higher standards in water pollution control (such as measures against eutrophication) and treated wastewater now plays an active role when it's reintroduced into the water cycle in the form of water for leisure activities or bathing water.

Although water in Germany is available in sufficient quantity and quality, the question of water reuse—in other words reusing treated wastewater—is critical to any debate about water supply. It becomes especially relevant, for example, in cases of local shortages and seasonal availability. These issues will not only continue to be exacerbated by climate change in the future, but will start to be felt on a wider scale as the global availability of water declines. The principle of

'Fit for Purpose' should apply here. This term refers to processing water for a specific use (irrigation, industrial, drinking water) thus making it possible to save energy and resources.

Owing to its poor biodegradability, there is evidence of several micropollutants in wastewater and even traces in drinking water. While it has still not been officially proven that micropollutants in water pose a risk to health, there is, naturally, a link between water protection and preventative health care. This means that extra physical processes are required. These include; (membrane) filtration, absorption via activated carbon and/or chemical processes such as oxidation with ozone. (Schaum et al., 2018) For this reason, large-scale facilities that can manage all these additional processes with scientific support on site are increasingly common: An impressive example is the plant belonging to the Bickenbach/Seeheim-Jugenheim wastewater association.

A discussion that is increasingly in the public domain concerns plastics and microplastics. Microplastics are plastic particles <5 mm, and their presence everywhere makes them the focus of science, political and societal debate. In water management, the challenge is to

develop contamination-free sampling and analysis procedures to detect microplastic particles in water, wastewater and sewage sludge samples, as well as to explore relevant elimination technologies. Of course, an interdisciplinary approach is essential. So while focus at the University is primarily placed on the best technology to do this, varied research into other areas is important. This includes social behaviour e.g. the use of synthetic fabrics and ecotoxicology e.g. the effect of chemicals on our ecosystem (PLASTRAT research project).

### **Sewage Sludge—A Building Block for the Energy Revolution?**

While sewage sludge does represent a pollutant risk, there is also massive potential to exploit it for the nutrients that it stores. These include phosphorus and nitrogen as well as chemically bound energy.

Phosphorus is a finite resource that is both essential and unique. The global deposits of mineral phosphates, mainly used in agriculture, can be found in only a few countries. During wastewater treatment, phosphorus is bound into the sewage sludge by means of the biological and chemical processes that the waste is exposed to. There is huge potential here for it to be

---

*left page · Figures 5 – 7*

---

*In the technical centre, test plants are operated to conduct research into new process approaches in the fields of water treatment and sustainable sewage sludge treatment.*



Figure 8

*Through the use of experimental reactors it is possible to research the influence of control parameters on biogas generation.*

used as a secondary raw material source. This would mean that in the future phosphorus contained in wastewater/sewage sludge/sewage sludge ash would be recycled—requiring the separation of nutrients from other pollutants. Technologies for recovering phosphorus are available for various application along the wastewater treatment plan—from wastewater treatment itself to sewage sludge and sewage sludge ash treatment. (Schaum, 2018) Nitrogen in wastewater could also be better harnessed as long as energy consumption is kept low in the process. This could play a bigger role in agricultural use cases.

Germany is currently on a mission to lead an energy revolution: One of the goals here is to see more renewable energies supplying the grid, especially wind and photovoltaics. But a typical hurdle is the strong fluctuations in power generation—making it hard to predict actual volumes. This calls for new technologies that are flexible, and ensure that electricity generation and consumption remain balanced. By using so-called co-substrates, such as organic residual materials from the food industry, biogas generation is possible during the water treatment process. Co-substrates hold

Figure 9

Gas potential of different substrates.

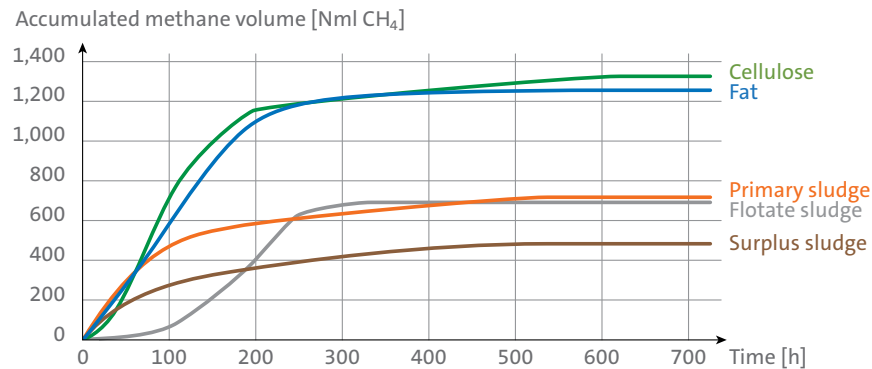

chemically bound energy (COMITO research project) and can be stored using thermal energy storage on site. (Hubert et al., 2019)

Biogas is the mixture of gases produced by the breakdown of organic matter in the absence of oxygen. It can be produced from organic raw materials such as sewage sludge or biowaste and is a renewable energy source. Biogas is produced by anaerobic digestion, in which material inside a closed system is digested. This closed system is called an anaerobic digester.

### From Water Processor to Water Service Provider

The Universität der Bundeswehr München will continue to research ways in which urban water management processes can be enhanced for the benefit of the citizens, communities and populations that rely on it. Going forward, this will see a continuation of research into the optimisation of sewage disposal, modernisation of piping systems

and 'Fit for Purpose' water use. In order to protect resources, the recovery of phosphorus and nitrogen must also start to happen on a wider scale.

Wastewater treatment will also start to play a key role in the energy revolution. Many treatment plants have already been built to accommodate flexible infrastructure that allow this. (Schaum, 2016) There is also leverage in the changing role of a consumer as a potential producer—self-generation models are in use and will become more popular. But critically, the potential wastewater treatment plants show in plugging the energy grid fluctuation gap is enormous: It is certainly possible to start storing energy now without compromising the main objective of wastewater treatment. This needs to be the subject of more experimentation.

In the future—by consolidating health, water, and resource protection—the wastewater treatment plant has the potential to transform itself from water treatment processor to water resource recovery facility and—ultimately—service provider.



**Univ.-Prof. Dr.-Ing. Christian Schaum**  
Department of Civil Engineering and Environmental Sciences

*Professor Christian Schaum works at the Department of Civil Engineering and Environmental Sciences. He is the head of the chair Sanitary Engineering and Waste Management. His main area of focus is in resource-oriented sustainable urban water management.*

*Christian Schaum is a member of the Research Centre RISK (Risk, Infrastructure, Security and Conflict).*



By Thomas W. Adam

# A Healthier Atmosphere: How Measuring Particles and Gaseous Pollutants Helps

Environmental news, catastrophes and climate forecasts frequently appear in the media. And it doesn't get more alarming than estimations from renowned researchers that global ambient air pollution may result in a range of between 4.2 million (World Health Organization) to 8.9 million (Burnett et al.) deaths per year. While Asia is affected the worst, Europe is also a serious cause for concern with up to 790,000 premature deaths per year. (Lelieveld et al.) At the same time, discussions surrounding bans on diesel, justified limit values for air pollutants and exhaust fraud by automotive companies divide the nation. But these issues don't just concern city planners, politicians, doctors and car manufacturers. They are top of the list for aerosol researchers.

## What is Aerosol Research?

Aerosols are solid and/or liquid airborne particles in a gaseous medium such as air. The size of the particles range between a few nanometres and several micrometres. And they can be of natural or anthropogenic origin. Natural aerosols include sea salt, desert dust or volcanic ash as well as pollen and spores. Anthropogenic aerosols include exhaust gases from transport, energy production, building heating or deforestation and emissions from industrial processes.

Aerosols can have a major influence on human health. Hence, they may cause allergies, lung cancer and chronic respiratory diseases. They can also trigger heart attacks and strokes (World Health Organization).

Based on current knowledge, aerosols are a big mystery when it comes to climate change. Depending on the size and chemical composition, aerosols may contribute

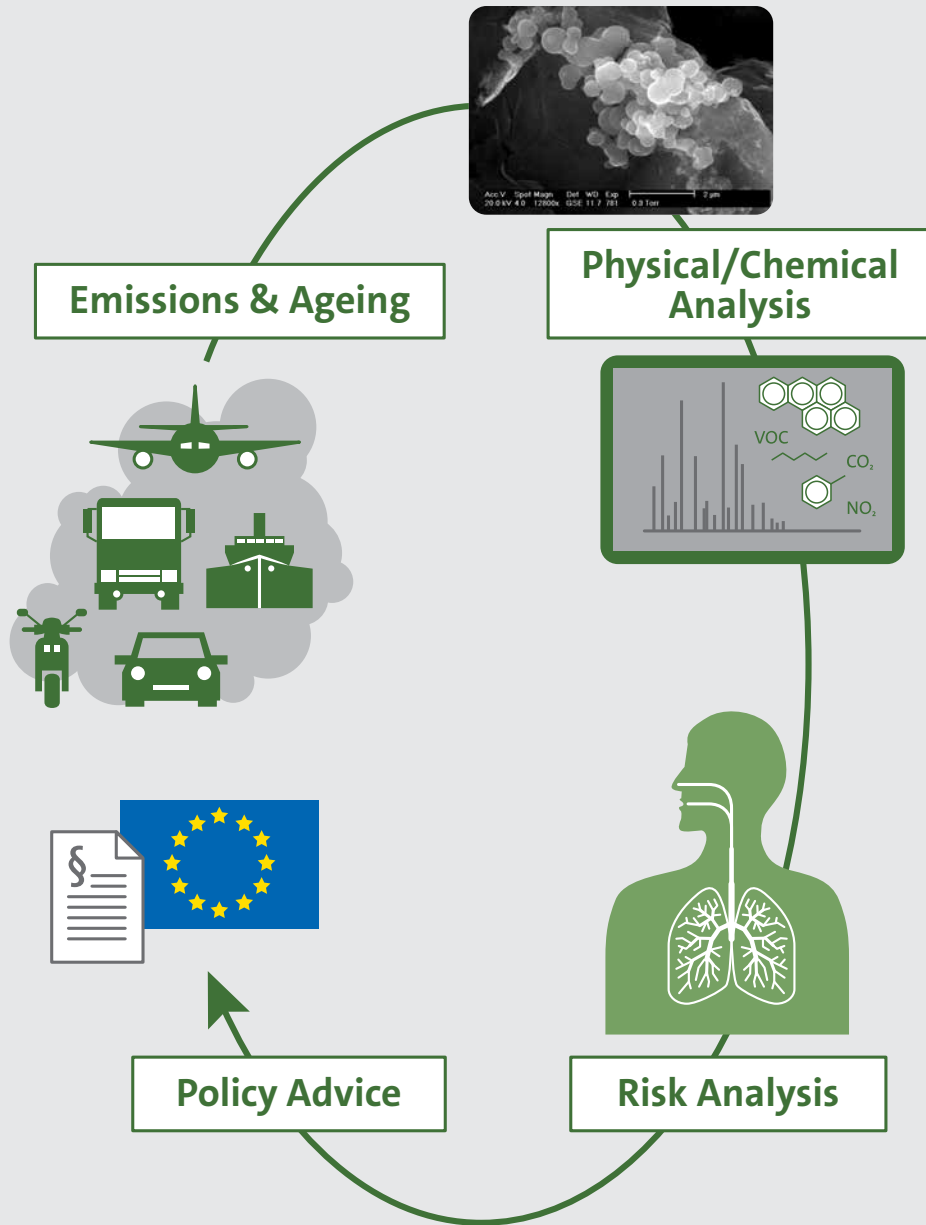

Figure 1

Research interests and fields of activity at the Institute of Chemistry and Environmental Engineering at the Faculty of Mechanical Engineering.

to climate cooling due to light scattering and cloud formation as well as to climate warming through energy absorption. Solid particles in the air are often simply referred to as fine dust. However, this fails to take account of the fact that these are complex systems sometimes consisting of thousands of individual substances. The chemical and physical properties of aerosols can be easily influenced and may change within a fraction of a second. Depending on ambient conditions, compounds may vary between the aggregate states of solid, liquid and gas. They can chemically react with one another or grow together to form larger particles. Under certain circumstances, aerosols survive in the atmosphere for many weeks where they are continually exposed to ageing processes.

These factors can strongly influence the impact that aerosols have on people and nature. And it can make aerosol research a highly demanding and complex

---

Figures 2–3

---

*Sample preparation and instrument tuning prior to chemical analysis.*



field—in particular in terms of the measurement technology required to investigate it properly. This is something the Universität der Bundeswehr München and its Institute of Chemistry and Environmental Engineering knows more than most. After all, the Institute is making groundbreaking progress in research related to the real-time measurement of gaseous organic pollutants in combustion processes.

### **The Role of the Institute of Chemistry and Environmental Engineering**

The Institute of Chemistry and Environmental Engineering at the Universität der Bundeswehr München specialises in the chemical analysis of environmental samples. The Institute has a broad range of measurement techniques at its disposal for the purpose of investigating organic and inorganic substances in liquid, solid and gaseous matrices.

Research activities focus on aerosol research, in particular, the chemical/physical characterisation of air pollutants and climate-relevant compounds, as well as on the measurement of exhaust gases in combustion processes. The focal point of current and future research lies in examining the exhaust gases of ship engines and aircraft turbines together with testing modern exhaust gas aftertreatment systems and fuels.

Another main emphasis is the research on transport-related emissions from non-combustion processes. This includes the abrasion of brakes, tires, drive components and of road surfaces. The Institute is headed up by Professor Adam—a member of the expert commission at UNECE (United Nations Economic Commission for Europe)—which is currently developing a statutory testing method to regulate brake dust in the automotive industry.

Another field of activity lies in investigating ageing processes in the atmosphere and their influence on the composition of urban, rural and Alpine ambient air. The chemical/physical tests carried out by the Institute of Chemistry and Environmental Engineering are supported by biological analyses (e.g. in vitro cell studies) conducted at the Helmholtz Zentrum München. The goal here is to provide an indication of potential health hazards for humans.

### **What is Real-Time Measurement with Photoionisation Time-of-Flight Mass Spectrometry?**

One of the Institute's specialist areas lies in the real-time measurement of gaseous organic pollutants in combustion processes. It's a procedure that has been codeveloped making it possible to simultaneously detect a large number of hydrocarbons at trace



4



5



6



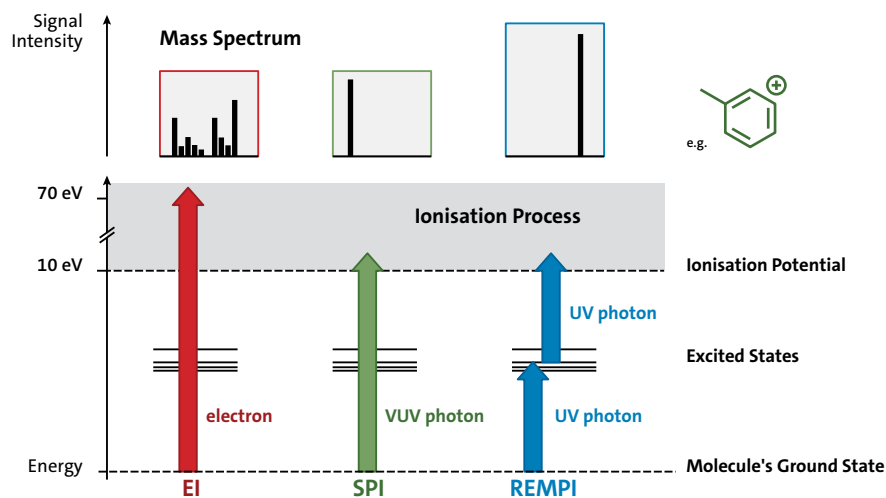

Figure 7

*Comparison of conventional Electron Impact Ionisation (EI), Single-Photon Ionisation (SPI) and Resonance-Enhanced Multiphoton Ionisation (REMPI).*

*left page · Figures 4 – 6*

*Physical investigations of brake particles with a home-built brake dynamometer (4) and microscope examinations of environmental samples (5, 6).*

levels which damage health. (e.g. Adam et al. 2011, Adam et al., 2012, Czech et al. 2017) This enables process control of combustion engines and industrial plants. In other words, while standard combustion measurements are being recorded, the concentration of carcinogenic compounds such as benzene, butadiene or polycyclic aromatic hydrocarbons (so-called PAHs) can simultaneously also be visualised. The effects of different engine settings, exhaust gas aftertreatments or different fuels are immediately displayed. The Institute uses the technique of time-of-flight mass spectrometry coupled with soft photoionisation processes to achieve this.

### Classic Mass Spectrometry

In classic mass spectrometry, the compounds to be analysed are ionised through bombardment with electrons, so-called Electron Impact Ionisation (EI). Ionisation is necessary in order to accelerate or deflect the charged molecules (ions) in the electric field of

the mass spectrometer. In order to achieve sufficient ionisation efficiency and therefore the detection limit, it is necessary to work with electron energies (usually 70 eV), which lead to fragmentation of the actual 'mother ion' through the simultaneous transfer of excess energy to the resulting ions. Identification in the mass spectrum, therefore, takes place via a substance-specific fragment pattern. This constitutes a 'hard ionisation procedure'. If a sample contains a large number of ionisable compounds, many signals may be superimposed. This means that a clear resolution or identification is then no longer possible. This is where the 'soft ionisation procedures' are necessary—in other words, techniques that suppress or even completely prevent fragmentation.

### Single-Photon Ionisation (SPI)

In order to do this, the Institute applies two photoionisation procedures with UV (ultra violet) or VUV (vacuum ultra violet) radiation. Lasers or excimer lamps serve as light sources. Excimer lamps currently in use generate photons with an energy of 10.5 eV. This roughly corresponds to the ionisation energy of most organic molecules. If molecules are bombarded with photons of this energy, it results in the absorption of a photon and ionisation occurs. The transferred excess energy is too little meaning that no fragmentation occurs. This procedure is referred to as Single-Photon Ionisation (SPI).

» The Institute's technical and scientific applications are numerous. But to stay ahead of the curve, strategic cross-discipline collaboration will be critical.

### Resonance-Enhanced Multiphoton Ionisation (REMPI)

The second ionisation process results in a successive absorption of at least two UV photons with an energy of approx. 5 eV. Following the absorption of the first photon, a (short-lived) excited state needs to be achieved as an intermediate step. This relates to a specific spectroscopic property of the molecule. The energy of 5 eV is selected so that this is the case with most aromatic hydrocarbons. The sum of both photon energies together results in ionisation. This procedure is called Resonance-Enhanced Multiphoton Ionisation (REMPI).

SPI provides a good overview of existing small aromatic and aliphatic hydrocarbons as well as some of the carbonyl compounds. REMPI, on the other hand, is very sensitive and selective for the detection of many PAHs.

The coupling of both photoionisation processes to a Time-of-Flight Mass Spectrometer (TOFMS), makes it possible for all target compounds to be detected

simultaneously and for the process to be continually repeated with very high time-resolution.

### The Future of Aerosol Research Lies in Cooperation

The Institute's technical and scientific applications are numerous. But to stay ahead of the curve, strategic cross-discipline collaboration will be critical. And this is just what's happening.

**Helmholtz Zentrum München:** In summer 2018, the Universität der Bundeswehr München signed an exciting cooperation agreement with the Helmholtz Zentrum München — the German Research Centre for Environmental Health. The Helmholtz Zentrum München has had close ties with the Universität Rostock in the field of aerosol research for many years.

The **Universität Rostock:** The Chair for Analytical Chemistry at the Institute of Chemistry of the Universität Rostock is Professor Dr Ralf Zimmermann,

who also heads the Comprehensive Molecular Analytics (CMA) Department at the Helmholtz Zentrum München.

**Universität der Bundeswehr München:** Professor Thomas W. Adam from the Institute of Chemistry and Environmental Engineering at the Faculty of Mechanical Engineering has been Deputy Institute Director of CMA since 2017.

Through this cooperation, approximately 50 scientists, technicians and engineers at Helmholtz Zentrum München (CMA), Universität Rostock (Chair of Analytical Chemistry) and the Universität der Bundeswehr München (Institute of Chemistry and Environmental Engineering) spanning chemistry, physics, engineering science and biology are currently working on the broad field of air pollution as well as its impact on human health and the environment. All three institutions thus benefit from the integration of classic scientific disciplines with health-related research and engineering disciplines.

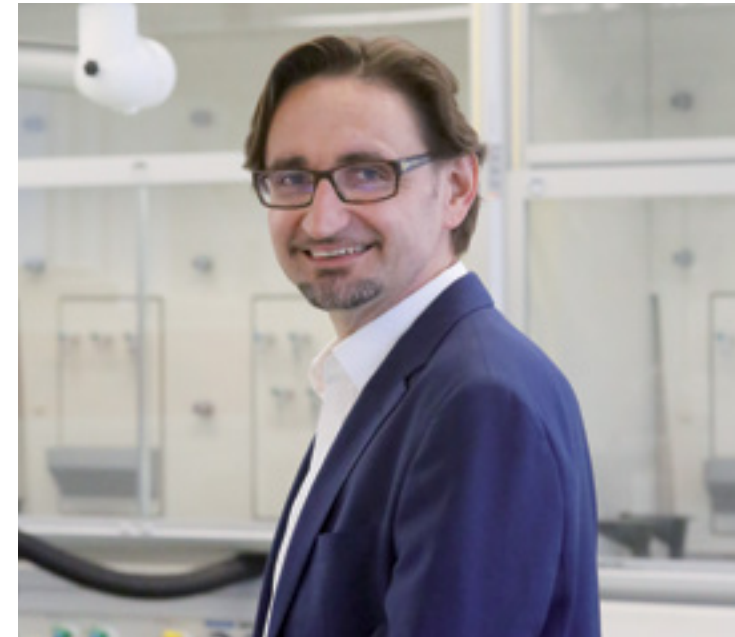

Figure 8

Research cooperation between the Universität der Bundeswehr München and the Helmholtz Zentrum München.

### The Future's Bright

So what lies in store for the Institute of Chemistry and Environmental Engineering? Currently, the team is evaluating techniques in order to reduce the pollutant input of maritime ship engines. The goal of the cooperation project, consisting of 10 partners from research and industry, is to test new exhaust gas aftertreatment systems and develop them to market maturity. In doing so, the Institute of Chemistry and Environmental Engineering is making a lasting contribution towards protecting the atmosphere and the maritime environment. And there's a lot more still to come.



#### **Prof. Dr. rer. nat. Thomas W. Adam**

Institute of Chemistry and Environmental Engineering

*Professor Thomas W. Adam works at the Faculty of Mechanical Engineering where he manages the Institute of Chemistry and Environmental Engineering. He is also Deputy Director at the Comprehensive Molecular Analytics Department at the Helmholtz Zentrum München – German Research Centre for Environmental Health.*

» New fuels based on sustainable solar and wind power or on biomass taken from plant residues can make a major contribution to CO<sub>2</sub>-neutral mobility.

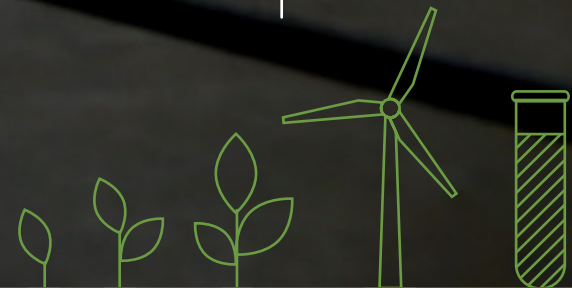

By Christian Trapp

# CO<sub>2</sub>-Neutral Mobility: From New Fuels to Innovative Combustion Processes

Our globally networked world is based on the mobility of data, people and goods. The greatest challenge to our society in terms of the last two are those of our climate and environmentally neutral transportation. Today motorcycles, cars, buses, trucks, articulated lorries, trains, ships and aeroplanes are predominantly powered by fossil fuel-burning engines or turbines. In the process carbon dioxide (CO<sub>2</sub>)—the major contributor to global warming—is emitted in large quantities. And—while air pollutants such as nitrogen oxides, hydrocarbons and formaldehyde are emitted in considerably smaller quantities—they can still have a significant impact on humans and the environment around us.

## **New Fuels for Existing Vehicles**

New fuels based on sustainable solar and wind power or on biomass taken from plant residues can make a major contribution to CO<sub>2</sub>-neutral mobility. Here the electricity is applied in the hydrolysis of water and the resulting hydrogen is either used directly as fuel (in fuel cells and internal combustion engines) or processed further. This further processing involves a synthesis using additional CO<sub>2</sub> from the air (Direct Air Capture) to methane (Power-to-Gas), to methanol, higher alcohols, or even to petrol and diesel-like fuels (Power-to-Liquid).

These processes can be designed in such a way that optimum combustion can take place in existing vehicle engines whilst at the same time minimising pollutant emissions. The same applies to fuels synthesised from plant residues (straw, especially rice straw, grass





Figures 1–2

*The optimisation of internal combustion engines for new CO<sub>2</sub>-neutral fuels is the central focus of research at the Institute. This can be monitored at the test bench (1) and the engine adjusted based on results (2).*

cuttings etc.) such as biogas (Biomass-to-Gas), ethanol or other diesel-like refinement stages (Biomass-to-Liquid).

With the exception of hydrogen, these synthetic fuels can be distributed through existing infrastructure (pipelines, filling stations) and—in the majority of cases—put into existing engines. Although these engines continue to emit CO<sub>2</sub>, it is removed from the air during fuel production or plant growth. This CO<sub>2</sub> cycle prevents any further increase in the CO<sub>2</sub> values in the air as a result of engine combustion.

In an attempt to restore environmental balance, these engines can be optimised specifically for the use of ‘Power-to-X’ and ‘Biomass-to-X’ fuels. Of particular

interest is what happens when they’re combined with hybrid propulsion which not only significantly increases vehicle efficiency but keeps air pollutant emissions to a minimum.

To bring these new processes to market takes not only the right scientific understanding but also the facilities to test and evaluate these new concepts. And this is just what scientists led by Professor Trapp at the Universität der Bundeswehr München have. In the heart of Munich, they are developing innovative combustion processes and their associated control systems. A simulation-driven development methodology allows complex ideas to be evaluated and implemented quickly. To achieve this, the University uses a ‘High Performance Cluster’ which

consists of commercial simulation programs with its own models for ignition, combustion and reaction kinetics built on top.

In parallel, investigations are being conducted into a thermodynamic single-cylinder engine with optical access for detailed analysis of ignition, flame propagation and pollutant formation. These help to confirm simulation results and validate successful models prior to the next stage of testing. Once this is done, a full engine test can be done on the vehicle itself—either on rollers or on a test track. Under real conditions, every development aspect can then be tested and optimised.



## Can mobility for everyone be achieved without damaging the climate?

New fuels based on 'green' wind and solar power as well as CO<sub>2</sub> from the air or plant remains can certainly help. At the Institute of Energy and Climate Research, Professor Christian Trapp and his team are researching drive technology. This involves combining synthetic fuels with innovative ideas for existing drive concepts (pure combustion engines and hybrid drives). And because research is also fun, the scientists work closely with the University's Formula Student racing team, so that their climate-neutral race car can win.

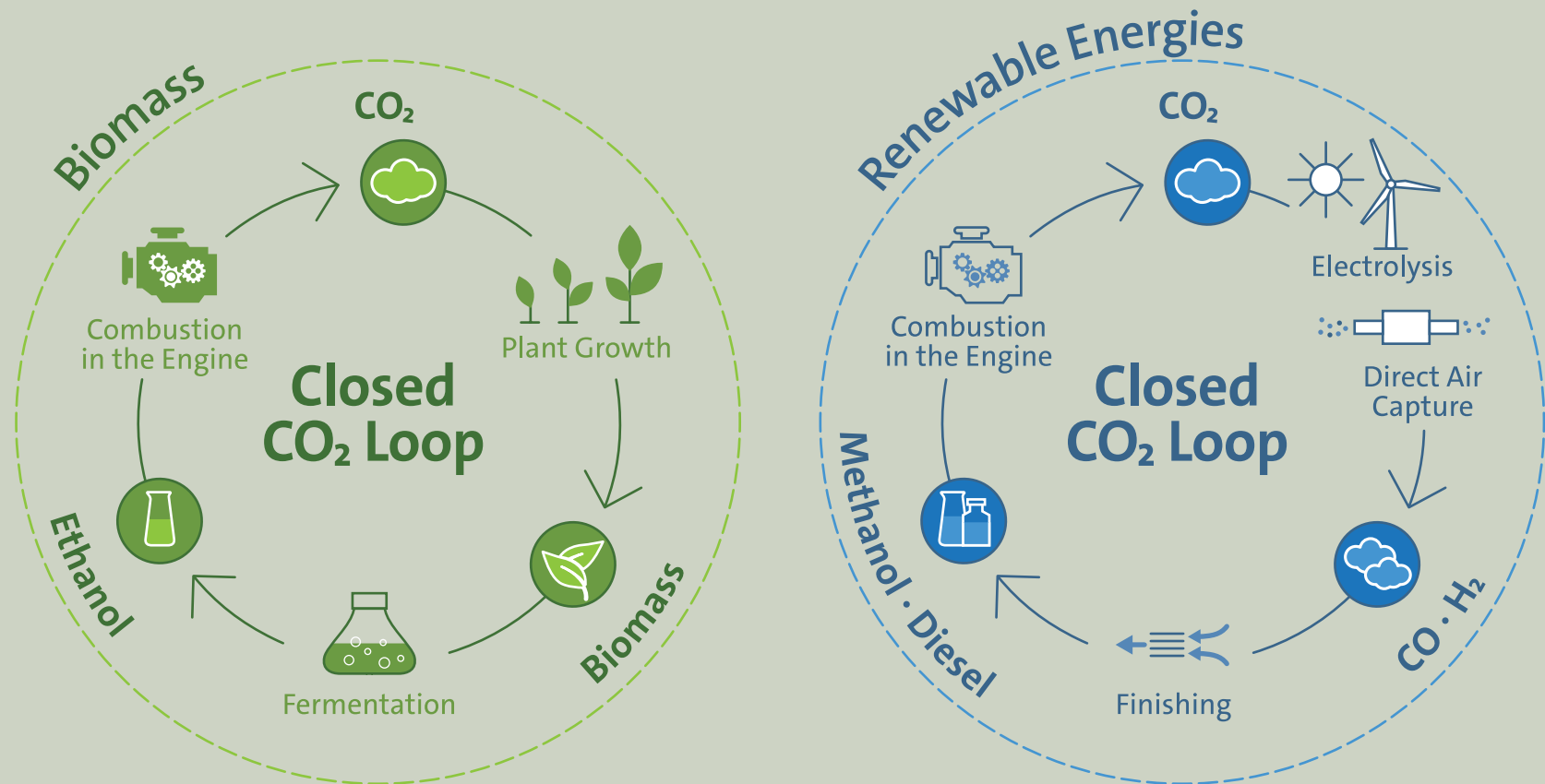



4

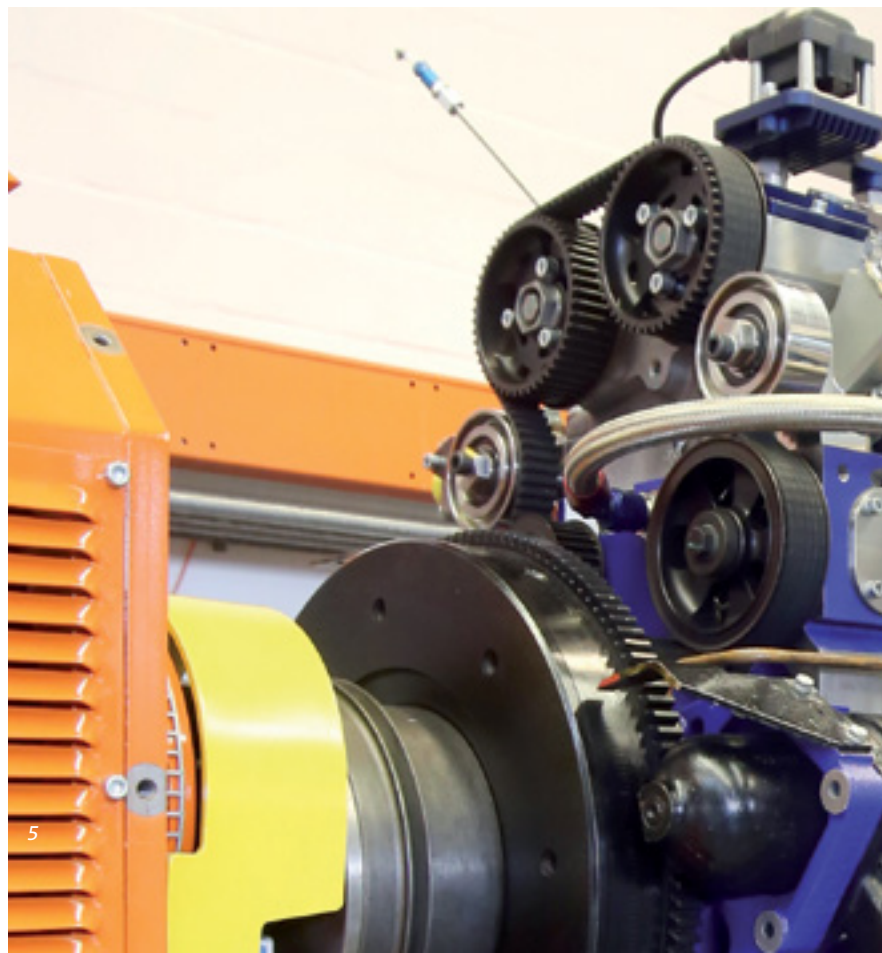

5

3



» The fast reaction sequence due to the high compression ratio and high excess air creates efficiencies of over 50%. Nitrogen oxide and particle emissions can be reduced by more than 95% and hydrocarbon and carbon monoxide emissions by 60–90%.

---

left page · Figures 3–5

---

*To develop new combustion concepts and pre-chamber spark plugs a lot of testing is involved. The roller dynamometer (3) connects to the engine test bench where combustion and emission data is analysed (4).*

*A closeup of single-cylinder research engine (5).*

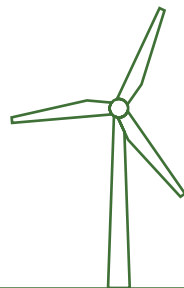

### **Pre-Chamber Combustion Processes: Rethinking Old Concepts**

The use of subdivided combustion chambers in combustion engines is certainly not new. Pre-chamber and swirl-chamber processes have long been standard features in a diesel engine. Today, pre-chamber combustion processes are widely used in the field of static industrial engines for gaseous fuels (natural gas, biogas) for power generation and use in block-type thermal power stations.

In these pre-chamber processes for petrol engines, optimum conditions for ignition and combustion are created in separated partial volumes (the pre-chamber generates about 0.5–3% of the total combustion chamber volume of which the spark plug is also a component). Temperature distribution, flow field, distribution of the air-fuel mix and the residual gases at the point of ignition all lead to rapid combustion in the pre-chamber. The resulting build up in pressure accelerates hot gas and radicals in the overflow holes to the main combustion chamber.

This triggers flame flares which lead to a fast and consistent, highly efficient, low emission conversion of the mixture in the main combustion chamber.

In the automotive industry (petrol engines for petrol and gas), these concepts have so far only played a role in racing cars. That's because in these vehicles it is primarily the full load engine range that matters—making optimisation at lower operating points possible. In the propulsion of conventional cars and lorries, however, all operating ranges from idle to full load are important. Particularly, as in everyday life, engines are mainly operated at partial load.

Modern concepts for the propulsion of conventional vehicles must enable the lowest possible CO<sub>2</sub> and air pollutant emissions across all operating ranges. However, using thermal behaviour, ignition and flame propagation for this purpose in the pre-chamber is very complex. Or at least it used to be. Nowadays—with the development methodology described so far—this is possible. In fact, in combination with synthetic fuels (methane, methanol, ethanol), the

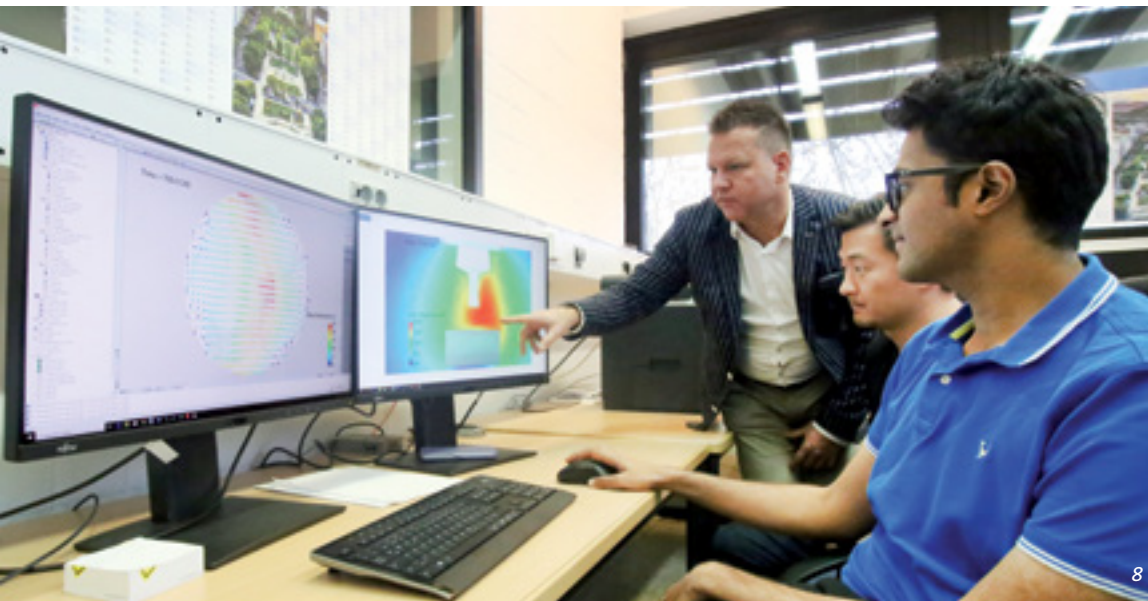
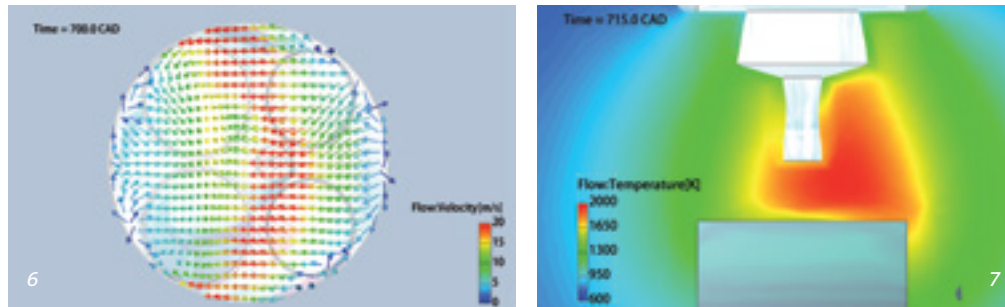

Figures 6–8

Simulation is a key part of gauging end success. This involves the use of the right simulation-driven development methodology (8) which generates simulated imagery. Examples include the simulation of in-cylinder flow field (6) and initial flame kernel development (7).

efficiency over the total driving cycle can be improved by 3–5% points compared to petrol engines operated with normal spark plugs. At the same time, raw emissions of hydrocarbons, carbon monoxide and nitrogen oxides can be reduced by 30% and particle emissions by more than 90%.

### RCCI—the Future Begins Today

Even greater potential for increasing efficiency and minimising pollutant emissions comes in the form of the so-called Reactivity Controlled Compression Ignition (RCCI) process.

In the process of RCCI, two fuels with significantly different ignition temperatures (e.g. 95–97% methane or ethanol and 3–5% diesel) are exposed to higher levels of excess air to create a homogeneous lean mixture. As in a diesel process, this mixture is ignited by compression in the combustion chamber of the engine. Due to the high level of excess air and the rapid volume reaction of the fuel conversion without flame front, the maximum combustion temperatures remain well below 2000 K so that hardly any nitrogen oxides are produced. The homogeneous lean mixture also prevents the formation of particles. This means that a simple oxidation catalyst is required for optimum process flow. This not only results in low hydrocarbon and carbon monoxide raw emission but also dispenses with the need for exhaust gas aftertreatment.



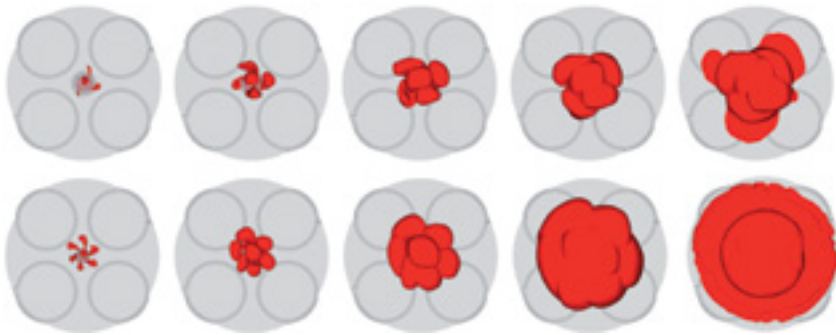

Figure 9

*This shows combustion optimisation achieved by using a pre-chamber spark plug. The upper row shows the baseline. The lower row, how efficiency and emissions are optimised.*

The fast reaction sequence due to the high compression ratio and high excess air creates efficiencies of over 50%. Nitrogen oxide and particle emissions can be reduced by more than 95% and hydrocarbon and carbon monoxide emissions by 60–90%.

Under normal circumstances, the sensitivity of the RCCI process represents a disadvantage in terms of rotation speed and load—making it very difficult to apply to conventional, combustion engine propulsion over the total operating range. This is not the case with hybrid vehicles: Here, the combustion engine can be optimised by one or a few operating points, since it is only used to generate electricity. A small battery storing a few kWh serves as a buffer for the electric motor used to drive the vehicle.



**Prof. Dr.-Ing. Christian Trapp**

Institute of Energie and Powertrain Technology

*Professor Christian Trapp deals with both classic internal combustion engines and alternative propulsion systems. His research areas include future fuels, new combustion methods, hybrid power trains and fuel cells for a CO<sub>2</sub> neutral mobility and power production.*

*Professor Trapp has been responsible for the performance and emission development of numerous engines ranging from motorbikes and automotive to marine transport as well as power generation applications around the world. His focus is always on the reduction of CO<sub>2</sub> and air pollutants while maintaining superior operations. His work has been published in various papers and textbooks and his presence requested at many international conferences.*

# Research Institute and Research Centers

It is of crucial importance for the further development of a university to promote its research reputation. The Universität der Bundeswehr München established the Research Institute CODE, four Research Centers—MARC, MOVE, RISK and SPACE—and CISS (the Center for Intelligence and Security Studies) in order to focus on its unique research expertise. The Research Institute, the four Research Centers and CISS join existing cooperation programs within the university, and serve as central points of contact for researchers both from within and outside it.

*The common goal of these institutions is to make the University's research achievements visible, and position them in the national and international research landscape. Further goals vary from institution to institution, and include promoting young scientists and user consultancy, as well as establishing and extending external research cooperation programs.*



The **Research Institute CODE (Cyber Defence)** is building one of the largest cybersecurity ecosystems in Europe, and is strongly supported by the Federal Ministry of Defence.

Since secure IT infrastructure is key to a digital, networked society, research and innovation are focused on areas that include network security, connected car and aeroplane technology, big data analytics, AI, quantum computing, critical infrastructures and e-health. 78 new positions have been assigned to the Research Institute, including 11 Chair and two Assistant Professor positions in cybersecurity.

**Departments:**

- Department of Computer Science*
- Department of Electrical Engineering and Information Technology*
- Department of Electrical Engineering and Computer Science*
- Department of Business and Organizational Sciences*
- Department of Aeronautics and Astronautics*



**MARC** is the **Military Aviation Research Center** of the Universität der Bundeswehr München. Together with the German Armed Forces, industry and public organisations, the

Research Center shapes the scientific and technological development of military aviation. In addition to key aeronautical topics such as propulsion, structures and aerodynamics, mission and automation topics, communication and navigation, as well as procurement, logistics and ethical issues are also covered.

**Departments:**

- Department of Aerospace Engineering*
- Department of Electrical Engineering and Information Technology*
- Department of Computer Science*
- Department of Economics and Organizational Sciences*
- Department of Social Sciences and Public Affairs*

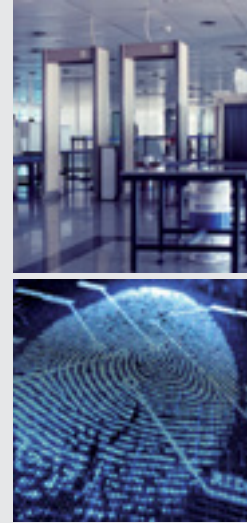

**MOVE (Modern Vehicles)** is a **Research Center** that, in the broadest sense, focuses on technological development within automotive research. It brings together scientists engaging in research on autonomous vehicles, electric and hybrid motors, driver assistance systems, as well as traffic.

**Departments:**

- Department of Electrical Engineering and Information Technology*
- Department of Aerospace Engineering*
- Department of Civil Engineering and Environmental Sciences*
- Department of Mechanical Engineering*



The researchers at the **Research Center RISK (Risk, Infrastructure, Security and Conflict)** have set themselves the goal of investigating the relationship between risk, infrastructure, security and conflict. To this end, RISK bundles competences from the social, natural and engineering sciences and sheds light on different risk and security perspectives in a multidisciplinary and multimethodological way. RISK's work is dedicated to the technical, political and social security of "critical infrastructures." These infrastructures are embedded in an area of tension between political requirements, social acceptance and willingness to pay. At the same time, they are put to the test in crisis situations such as natural disasters, international terrorism and organized crime.

**Departments:**

- Department of Civil Engineering and Environmental Sciences*
- Department of Social Sciences and Public Affairs*
- Department of Computer Science*
- Department of Economics and Organizational Science*
- Department of Human Sciences*
- Department of Business Administration*

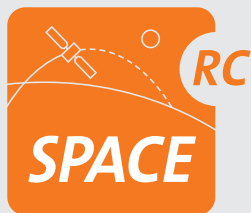

Today's modern life is hugely dependent on space-based services from orbit. The Universität der Bundeswehr München has dedicated itself to comprehensive research

and teaching in the field of space travel, and its associated services and applications. In the same way that many subject areas are interdisciplinary, so too is the setup at the **SPACE Research Center**. Thus, the Center focuses on a variety of relevant fields that include mission & system design, satellite technology and operation, satellite communications, satellite navigation and observations of Earth. In so doing, the SPACE Research Center provides a central platform for cross-discipline and integrated research into Space.

**Departments:**

- Department of Aerospace Engineering*
- Department of Electrical Engineering and Information Technology*
- Department of Computer Science*



The **Center for Intelligence and Security Studies (CISS)** was founded in September 2017 at the Universität der Bundeswehr München. Its objectives are to promote

interdisciplinary research activities, to organize and coordinate the Master's Program in Intelligence and Security Studies (MISS), and to advise political leaders in the field of security studies. In addition, CISS makes an active contribution to the global network of key players in the field and provides a common platform for all stakeholders. CISS benefits from the extraordinary resources of a world-class research institution and ensures extensive support for its researchers, students, and fellow partners. In both its research and teaching, CISS pursues fundamental knowledge as well as multidisciplinary collaborations that make technology more effective in solving complex societal problems.

**Departments:**

- Open to all Departments of the Universität der Bundeswehr München, and the departmental branch of the Intelligence Services of the Federal University of Applied Administrative Sciences*

## Digitalised World

### Augmented Reality: Marketing Gimmick or Serious Disruptor?

By Philipp A. Rauschnabel

Boston Consulting Group (2018). Augmented Reality: Is the Camera the Next Big Thing in Advertising? URL: <https://www.bcg.com/de-de/publications/2018/augmented-reality-is-camera-next-big-thing-advertising.aspx>

Kunkel, N., Soechtig, S., Miniman, J., Stauch, C., 2016. Augmented and Virtual Reality Go to Work, Deloitte Report., URL: <https://www2.deloitte.com/insights/us/en/focus/tech-trends/2016/augmented-and-virtual-reality.html>

Oleynick, V.C., Thrash, T.M., LeFev, M.C., Moldovan, E.G., Kieffaber, P.D., 2014. The Scientific study of Inspiration in the creative process: challenges and opportunities. *Frontiers in Human Neuroscience*, 8, 1–8.

Rauschnabel, P. A. (2018). Virtually enhancing the real world with holograms: An exploration of expected gratifications of using augmented reality smart glasses. *Psychology & Marketing*, 35(8), 557–572.

Rauschnabel, P. A., Felix, R., & Hinsch, C. (2019). Augmented reality marketing: How mobile AR-apps can improve brands through inspiration. *Journal of Retailing and Consumer Services*, 49, 43–53.

Rauschnabel, P. A., He, J., & Ro, Y. K. (2018). Antecedents to the adoption of augmented reality smart glasses: A closer look at privacy risks. *Journal of Business Research*, 92, 374–384.

Thrash, T.M., Maruskin, L.A., Cassidy, S.E., Fryer, J.W., Ryan, R.M., 2010. Mediating between the muse and the masses: inspiration and the actualization of creative ideas. *Journal of Personality and Social Psychology*, 98 (3), 469–487.

### Future Work in a Data Society

By Stephan Kaiser and Verena Bader

Bader, V. and Kaiser, S. (Ed.) (forthcoming): Arbeit in der Data Society – Herausforderungen, Chancen und Zukunftsvisionen für Mitbestimmung und Personalmanagement [Work in a Data Society – Challenges, Opportunities and Future Visions for Co-Determination and Human Resource Management]. Wiesbaden: Springer.

Bader, Verena; Kaiser, Stephan 2019: Algorithmic Decision-Making? The User Interface and Its Role for Human Involvement in Decisions Supported by Artificial Intelligence, in: *Organization* 26 (5), S. 655–672.

Bader, V. and Kaiser, S. (2017): Autonomy and control? How Heterogeneous Sociomaterial Assemblages Explain Paradoxical Rationalities in the Digital Workplace, in: *management revue*, 28(3), pp. 338–358.

Faraj, S., Pachidi, S., & Sayegh, K. (2018). Working and Organizing in the Age of the Learning Algorithm. *Information and Organisation*, 28(1), 62–70.

Günther WA, Mehrizi MHR, Huysman M and Feldberg F (2017) Debating Big Data: a Literature Review on Realizing Value from Big Data. *The Journal of Strategic Information Systems* 26(3): 191–209.

Jager, A., Rauch, R., Thiemann, D. & Kaiser, S. (2019). Die sechs Gefahren der digitalen Arbeitswelt – und was Sie dagegen tun können [The Six Dangers of the Digital World of Work and What You Can Do About It]. *Personalmagazin*, 48–52.

Kaiser, S. and Kraus, H. (2014). Big Data im Personalmanagement. Erste Anwendungen und ein Blick in die Zukunft [Big Data in Human Resource Management. First Applications and a View to the Future]. *Zeitschrift Führung + Organisation*, (83), 379–385.

Kaiser, S. and Loscher, G. (2018): People Analytics – Die Zukunft des Personalmanagements [People Analytics – The Future of Human Resource Management], in: Surrey, Heike/Tiberius, Victors: Die Zukunft des Personalmanagements [The Future of Human Resources Management] – 2025: Herausforderungen, Lösungsansätze und Gestaltungsoptionen [Challenges, Solutions and Design Options], vdf Hochschulverlag, Zurich.

Thiemann, D., Kozica, A., Rauch, R. & Kaiser, S. (2019). Digitalisierungs-atlas [Digitalisation Atlas] Zeitschrift Führung + Organisation, (2), 114–121.

Zarsky, T. (2016): The Trouble with Algorithmic Decisions: An Analytic Road Map to Examine Efficiency and Fairness in Automated and Opaque Decision Making. *Science, Technology, & Human Values*, 41(1), 118–132.

Zuboff, S. (2015). Big Other: Surveillance Capitalism and the Prospects of an Information Civilization. *Journal of Information Technology*, 30(1), 75–89.



## Tomorrow's Environment

### **Future Ready: Sustainable Urban Water Management**

By Christian Schaum

BMI (2009): Nationale Strategie zum Schutz Kritischer Infrastrukturen (KRITIS-Strategie) [National Strategy for Critical Infrastructure Protection (CIP Strategy)]

Krause, S. (2017): Planungsprozesse optimieren, interkommunale Zusammenarbeit verbessern [Optimising Planning Processes, Improving Inter-municipal Cooperation] - Research Project on the Development of Planning Tools for Water Management; Transforming Cities, 1|2017 pp. 51-53

Broß, L.; Wienand, I., Krause, S. (2019): BBK-Fachinformation 'Sicherheit der Trinkwasserversorgung Teil II: Notfallvorsorgeplanung' [Safety of Drinking Water Supply Part II: Emergency Supply Planning]

Hubert, C.; Steiniger, B.; Schaum, C.; Michel, M.; Spallek, M. (2019): Variation of the Digester Temperature in the Annual Cycle – Using the Digester As Heat Storage; Water Practice and Technology, IWA-Publishing, WPT-EM18220R1, London

Schaum C. (2016): Abwasserbehandlung der Zukunft: Gesundheits-, Gewässer- und Ressourcenschutz, Habilitation, [Wastewater Treatment of the Future: Health, Water and Resource Protection, Habilitation] Publication Series IWAR 233, ISBN 978-3-940897-32-9, Darmstadt

Schaum C. (2018), Ed.: Phosphorus: Polluter and Resource of the Future: Removal and Recovery from Wastewater, IWA-Publishing, ISBN 978-1-780408-35-4, London

Schaum, C.; Krause, S.; Mundani, A. (2018): Weitergehende Behandlung von Kläranlagenabläufen Weitergehende Nährstoff-elimination, Mikroverunreinigungen, Mikroplastik und Keime, [More Stringent Treatment of Sewage Plant Processes, Further Nutrient Elimination, Micropollutants, Microplastic, and Germs] DWA - WasserWirtschafts-Kurs Q/2: Kommunale Abwasserbehandlung, 07.-09.11.2018, Göttingen

UN (2012): The Millennium Development Goals Report, United Nations, New York

COMITO - Die Kläranlage in der Interaktion mit der Abfall- und Energiewirtschaft: Ein Deutsch-Österreichischer Dialog (COMITO), Verbundprojekt (Gesamtkoordination Universität der Bundeswehr München, Professur für Siedlungswasserwirtschaft und Abfalltechnik) gefördert durch EFRE – Europäischer Fonds für Regionale Entwicklung, [COMITO - The Treatment Plant in Interaction with the Waste and Energy Industry: A German-Austrian Dialogue (COMITO), Joint Project (Overall Coordination Universität der Bundeswehr München, Professor for Urban Sanitation and Waste Engineering) funded by EFRE - European Regional Development Fund] Project Duration 2018 – 2019

SYSTEM - Synergy of Integrated Sensors and Technologies for Urban Secured Environment, Joint Project Funded By European Commission, EU-Horizon 2020 Programme, Grant-Agreement No. 787128, Project Duration: 2018 – 2021, [www.systemproject.eu](http://www.systemproject.eu)

PLASTRAT - Strategies for the Reduction of Urban Plastic Emissions into Limnic Systems, Joint Project (Overall Coordination Universität der Bundeswehr München, Professor for Urban Sanitation and Waste Engineering) funded by the Federal Ministry of Education and Research (BMBF) within the research focus 'Plastic in the Environment – Sources, Sinks, Solution Approaches', Project Duration: 2017 – 2020, Funding Code: 02WPL1446 A-J, [www.plastrat.de](http://www.plastrat.de)

### **A Healthier Atmosphere: How Measuring Particles and Gaseous Pollutants Helps**

By Thomas W. Adam

Adam et al. 2011: 'Application of Modern On-line Instrumentation for Chemical Analysis of Gas Phase and Particulate Phase of Heavy Duty Vehicle Exhaust at the Novel European Commission Test Facility'; Analytical Chemistry; 2011, 83, pp. 67-76

Adam et al. 2012: 'Real-time Analysis of Aromatics in Vehicle Exhaust by Resonance-enhanced Multiphoton Ionization Time-of-flight Mass Spectrometry (REMPI-TOFMS): A Robust Tool for Chassis Dynamometer Testing'; Analytical and Bioanalytical Chemistry, 2012, 404, pp. 273-276

Czech et al. 2017: 'A Chemometric Investigation of Aromatic Emission Profiles from a Marine Engine in Comparison with Residential Wood Combustion and Road Traffic: Implications for Source Apportionment Inside and Outside Sulphur Emission Control Areas'; Atmospheric Environment, 167, pp. 212-222.

Burnett et al.: 'Global Estimates of Mortality Associated with Long-Term Exposure to Outdoor Fine Particulate Matter', Proc Natl Acad Sci USA (2018), 115 (38), pp. 9592-9597

Lelieveld et al.: 'Cardiovascular Disease Burden from Ambient Air Pollution in Europe Reassessed Using Novel Hazard Ratio Functions', European Heart Journal (2019), 40 (20), pp. 1590-1596

World Health Organization: 'Ambient air pollution: Health impacts', <https://www.who.int/airpollution/ambient/health-impacts/en/>

#### Universität der Bundeswehr München

Werner-Heisenberg-Weg 39  
85577 Neubiberg  
Germany  
Tel.: +49 89 6004-0  
info@unibw.de  
www.unibw.de  
ISSN 2510-1714

#### Publisher

**Univ.-Prof. Dr. phil. Merith Niehuss,**  
President at the Universität der Bundeswehr München  
**Univ.-Prof. Dr.-Ing. Dr. mont. Eva-Maria Kern,**  
Vice-President Research at the  
Universität der Bundeswehr München

#### Authors

Prof. Dr. rer. nat. Thomas W. Adam  
Dr. Tom Andert  
Verena Bader M.A.  
Univ.-Prof. Dr. Christina Binder, E.MA  
Univ.-Prof. Dr.-Ing. Roger Förstner  
Juniorprof. Dr.-Ing. Christian Hofmann  
apl. Univ.-Prof. Dr. rer. nat. Marko Hofmann  
Univ.-Prof. Dr. rer. nat. Wolfgang Hommel  
Univ.-Prof. Dr. rer. nat. Christian J. Kähler  
Univ.-Prof. Dr. rer. pol. Stephan Kaiser  
Univ.-Prof. Dr.-Ing. Andreas Knopp MBA  
Univ.-Prof. Mag. Dr. Thomas Pany  
Prof. Dr. Philipp A. Rauschnabel  
Univ.-Prof. Dr. rer. pol. Jasmin Riedl  
Dr. rer. nat. Sven Scharnowski  
Univ.-Prof. Dr.-Ing. Christian Schaum  
Dr.-Ing. Robert Schwarz  
Prof. Dr.-Ing. Christian Trapp

#### Design and Coordination

Just Imagine, Germering  
Susanne Koppenhöfer, Thomas Benz  
Universität der Bundeswehr München, Neubiberg  
Achim Vogel, Michael Brauns (Press and Communication)  
Kristina Kudlich

#### English Localisation/Editing

executive english, Munich  
Beth Negus and Philippa Carr

This edition uses British English throughout  
with the exception of pages 100–103.

#### Printing

Alfred Hintermaier, Offsetdruckerei + Verlag, Munich  
Circulation 2,000

© 2020 all communications should be directed to the Universität der Bundeswehr München, Corporate Communications, Werner-Heisenberg-Weg 39, 85577 Neubiberg, Germany.

All rights reserved. Brief citing from this magazine can be done with the express reference to the Professor/author in conjunction with the following source: 'Research Spotlights. Universität der Bundeswehr München. Edition 2, 2020.' Reprinting, publication both on and offline and large citations require the authorisation of the Universität der Bundeswehr München directly.





**Universität der Bundeswehr München**

Werner-Heisenberg-Weg 39  
85577 Neubiberg  
Germany

Tel.: +49 89 6004-0  
[info@unibw.de](mailto:info@unibw.de)  
[www.unibw.de](http://www.unibw.de)